

ATMEL 8-BIT MICROCONTROLLER WITH 4/8/16/32KBYTES IN-SYSTEM PROGRAMMABLE FLASH

Features

- High Performance, Low Power Atmel® AVR® 8-Bit Microcontroller Family
- Advanced RISC Architecture
 - 131 Powerful Instructions – Most Single Clock Cycle Execution
 - 32 x 8 General Purpose Working Registers
 - Fully Static Operation
 - Up to 20 MIPS Throughput at 20MHz
 - On-chip 2-cycle Multiplier
- High Endurance Non-volatile Memory Segments
 - 4/8/16/32KBytes of In-System Self-Programmable Flash program memory
 - 256/512/512/1KBytes EEPROM
 - 512/1K/1K/2KBytes Internal SRAM
 - Write/Erase Cycles: 10,000 Flash/100,000 EEPROM
 - Data retention: 20 years at 85°C/100 years at 25°C⁽¹⁾
 - Optional Boot Code Section with Independent Lock Bits
 - In-System Programming by On-chip Boot Program
 - True Read-While-Write Operation
 - Programming Lock for Software Security
- Atmel® QTouch® library support
 - Capacitive touch buttons, sliders and wheels
 - QTouch and QMatrix® acquisition
 - Up to 64 sense channels
- Peripheral Features
 - Two 8-bit Timer/Counters with Separate Prescaler and Compare Mode
 - One 16-bit Timer/Counter with Separate Prescaler, Compare Mode, and Capture Mode
 - Real Time Counter with Separate Oscillator
 - Six PWM Channels
 - 8-channel 10-bit ADC in TQFP and QFN/MLF package
 - Temperature Measurement
 - 6-channel 10-bit ADC in PDIP Package
 - Temperature Measurement
 - Programmable Serial USART
 - Master/Slave SPI Serial Interface
 - Byte-oriented 2-wire Serial Interface (Philips I²C compatible)
 - Programmable Watchdog Timer with Separate On-chip Oscillator
 - On-chip Analog Comparator
 - Interrupt and Wake-up on Pin Change

- Special Microcontroller Features
 - Power-on Reset and Programmable Brown-out Detection
 - Internal Calibrated Oscillator
 - External and Internal Interrupt Sources
 - Six Sleep Modes: Idle, ADC Noise Reduction, Power-save, Power-down, Standby, and Extended Standby
- I/O and Packages
 - 23 Programmable I/O Lines
 - 28-pin PDIP, 32-lead TQFP, 28-pad QFN/MLF and 32-pad QFN/MLF
- Operating Voltage:
 - 1.8 - 5.5V
- Temperature Range:
 - -40°C to 85°C
- Speed Grade:
 - 0 - 4MHz@1.8 - 5.5V, 0 - 10MHz@2.7 - 5.5.V, 0 - 20MHz @ 4.5 - 5.5V
- Power Consumption at 1MHz, 1.8V, 25°C
 - Active Mode: 0.2mA
 - Power-down Mode: 0.1µA
 - Power-save Mode: 0.75µA (Including 32kHz RTC)

1. Pin Configurations

Figure 1-1. Pinout ATmega48A/PA/88A/PA/168A/PA/328/P

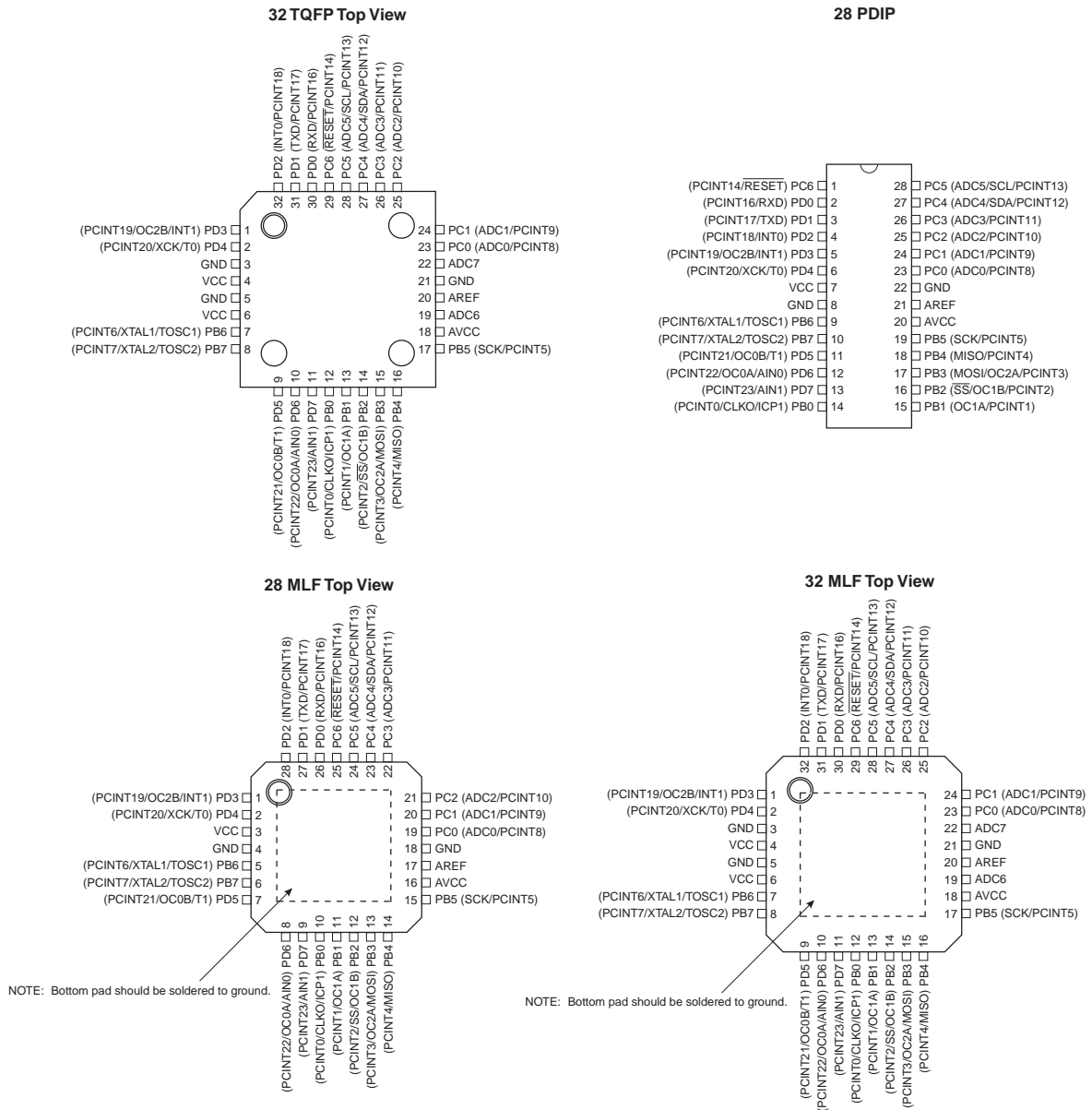

Table 1-1. 32UFPGA - Pinout ATmega48A/48PA/88A/88PA/168A/168PA

	1	2	3	4	5	6
A	PD2	PD1	PC6	PC4	PC2	PC1
B	PD3	PD4	PD0	PC5	PC3	PC0
C	GND	GND			ADC7	GND
D	VDD	VDD			AREF	ADC6
E	PB6	PD6	PB0	PB2	AVDD	PB5
F	PB7	PD5	PD7	PB1	PB3	PB4

1.1 Pin Descriptions

1.1.1 VCC

Digital supply voltage.

1.1.2 GND

Ground.

1.1.3 Port B (PB7:0) XTAL1/XTAL2/TOSC1/TOSC2

Port B is an 8-bit bi-directional I/O port with internal pull-up resistors (selected for each bit). The Port B output buffers have symmetrical drive characteristics with both high sink and source capability. As inputs, Port B pins that are externally pulled low will source current if the pull-up resistors are activated. The Port B pins are tri-stated when a reset condition becomes active, even if the clock is not running.

Depending on the clock selection fuse settings, PB6 can be used as input to the inverting Oscillator amplifier and input to the internal clock operating circuit.

Depending on the clock selection fuse settings, PB7 can be used as output from the inverting Oscillator amplifier.

If the Internal Calibrated RC Oscillator is used as chip clock source, PB7...6 is used as TOSC2...1 input for the Asynchronous Timer/Counter2 if the AS2 bit in ASSR is set.

The various special features of Port B are elaborated in ["Alternate Functions of Port B" on page 82](#) and ["System Clock and Clock Options" on page 27](#).

1.1.4 Port C (PC5:0)

Port C is a 7-bit bi-directional I/O port with internal pull-up resistors (selected for each bit). The PC5...0 output buffers have symmetrical drive characteristics with both high sink and source capability. As inputs, Port C pins that are externally pulled low will source current if the pull-up resistors are activated. The Port C pins are tri-stated when a reset condition becomes active, even if the clock is not running.

1.1.5 PC6/RESET

If the RSTDISBL Fuse is programmed, PC6 is used as an I/O pin. Note that the electrical characteristics of PC6 differ from those of the other pins of Port C.

If the RSTDISBL Fuse is unprogrammed, PC6 is used as a Reset input. A low level on this pin for longer than the minimum pulse length will generate a Reset, even if the clock is not running. The minimum pulse length is given in [Table 29-11 on page 305](#). Shorter pulses are not guaranteed to generate a Reset.

The various special features of Port C are elaborated in ["Alternate Functions of Port C" on page 85](#).|

1.1.6 Port D (PD7:0)

Port D is an 8-bit bi-directional I/O port with internal pull-up resistors (selected for each bit). The Port D output buffers have symmetrical drive characteristics with both high sink and source capability. As inputs, Port D pins that are externally pulled low will source current if the pull-up resistors are activated. The Port D pins are tri-stated when a reset condition becomes active, even if the clock is not running.

The various special features of Port D are elaborated in ["Alternate Functions of Port D" on page 88](#).

1.1.7 AV_{CC}

AV_{CC} is the supply voltage pin for the A/D Converter, PC3:0, and ADC7:6. It should be externally connected to V_{CC} , even if the ADC is not used. If the ADC is used, it should be connected to V_{CC} through a low-pass filter. Note that PC6...4 use digital supply voltage, V_{CC} .

1.1.8 AREF

AREF is the analog reference pin for the A/D Converter.

1.1.9 ADC7:6 (TQFP and QFN/MLF Package Only)

In the TQFP and QFN/MLF package, ADC7:6 serve as analog inputs to the A/D converter. These pins are powered from the analog supply and serve as 10-bit ADC channels.

2. Overview

The ATmega48A/PA/88A/PA/168A/PA/328/P is a low-power CMOS 8-bit microcontroller based on the AVR enhanced RISC architecture. By executing powerful instructions in a single clock cycle, the ATmega48A/PA/88A/PA/168A/PA/328/P achieves throughputs approaching 1 MIPS per MHz allowing the system designer to optimize power consumption versus processing speed.

2.1 Block Diagram

Figure 2-1. Block Diagram

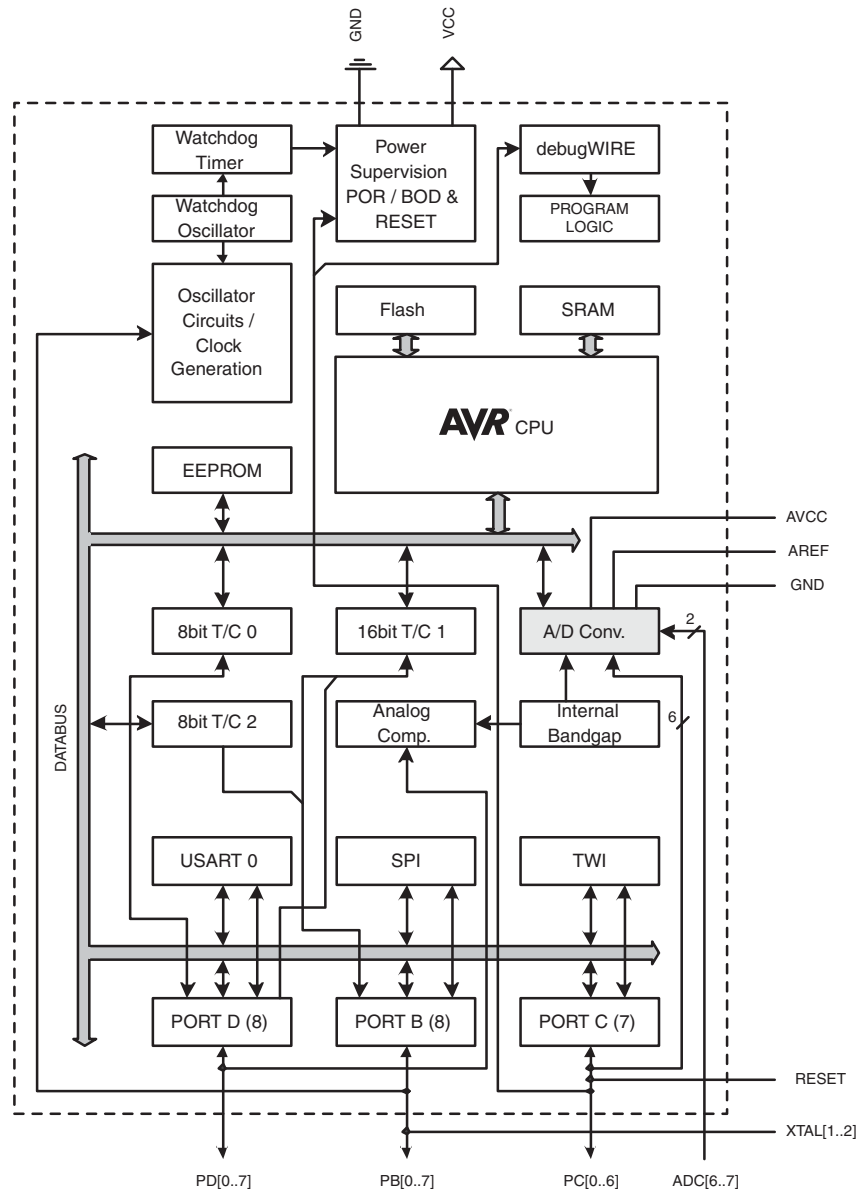

The AVR core combines a rich instruction set with 32 general purpose working registers. All the 32 registers are directly connected to the Arithmetic Logic Unit (ALU), allowing two independent registers to be accessed in one single instruction executed in one clock cycle. The resulting architecture is more code efficient while achieving throughputs up to ten times faster than conventional CISC microcontrollers.

The ATmega48A/PA/88A/PA/168A/PA/328/P provides the following features: 4K/8Kbytes of In-System Programmable Flash with Read-While-Write capabilities, 256/512/512/1Kbytes EEPROM, 512/1K/1K/2Kbytes SRAM, 23 general purpose I/O lines, 32 general purpose working registers, three flexible Timer/Counters with compare modes, internal and external interrupts, a serial programmable USART, a byte-oriented 2-wire Serial Interface, an SPI serial port, a 6-channel 10-bit ADC (8 channels in TQFP and QFN/MLF packages), a programmable Watchdog Timer with internal Oscillator, and five software selectable power saving modes. The Idle mode stops the CPU while allowing the SRAM, Timer/Counters, USART, 2-wire Serial Interface, SPI port, and interrupt system to continue functioning. The Power-down mode saves the register contents but freezes the Oscillator, disabling all other chip functions until the next interrupt or hardware reset. In Power-save mode, the asynchronous timer continues to run, allowing the user to maintain a timer base while the rest of the device is sleeping. The ADC Noise Reduction mode stops the CPU and all I/O modules except asynchronous timer and ADC, to minimize switching noise during ADC conversions. In Standby mode, the crystal/resonator Oscillator is running while the rest of the device is sleeping. This allows very fast start-up combined with low power consumption.

Atmel® offers the QTouch® library for embedding capacitive touch buttons, sliders and wheels functionality into AVR® microcontrollers. The patented charge-transfer signal acquisition offers robust sensing and includes fully debounced reporting of touch keys and includes Adjacent Key Suppression® (AKS™) technology for unambiguous detection of key events. The easy-to-use QTouch Suite toolchain allows you to explore, develop and debug your own touch applications.

The device is manufactured using Atmel's high density non-volatile memory technology. The On-chip ISP Flash allows the program memory to be reprogrammed In-System through an SPI serial interface, by a conventional non-volatile memory programmer, or by an On-chip Boot program running on the AVR core. The Boot program can use any interface to download the application program in the Application Flash memory. Software in the Boot Flash section will continue to run while the Application Flash section is updated, providing true Read-While-Write operation. By combining an 8-bit RISC CPU with In-System Self-Programmable Flash on a monolithic chip, the Atmel ATmega48A/PA/88A/PA/168A/PA/328/P is a powerful microcontroller that provides a highly flexible and cost effective solution to many embedded control applications.

The ATmega48A/PA/88A/PA/168A/PA/328/P AVR is supported with a full suite of program and system development tools including: C Compilers, Macro Assemblers, Program Debugger/Simulators, In-Circuit Emulators, and Evaluation kits.

2.2 Comparison Between Processors

The ATmega48A/PA/88A/PA/168A/PA/328/P differ only in memory sizes, boot loader support, and interrupt vector sizes. [Table 2-1](#) summarizes the different memory and interrupt vector sizes for the devices.

Table 2-1. Memory Size Summary

Device	Flash	EEPROM	RAM	Interrupt Vector Size
ATmega48A	4KBytes	256Bytes	512Bytes	1 instruction word/vector
ATmega48PA	4KBytes	256Bytes	512Bytes	1 instruction word/vector
ATmega88A	8KBytes	512Bytes	1KBytes	1 instruction word/vector
ATmega88PA	8KBytes	512Bytes	1KBytes	1 instruction word/vector
ATmega168A	16KBytes	512Bytes	1KBytes	2 instruction words/vector
ATmega168PA	16KBytes	512Bytes	1KBytes	2 instruction words/vector
ATmega328	32KBytes	1KBytes	2KBytes	2 instruction words/vector
ATmega328P	32KBytes	1KBytes	2KBytes	2 instruction words/vector

ATmega48A/PA/88A/PA/168A/PA/328/P support a real Read-While-Write Self-Programming mechanism. There is a separate Boot Loader Section, and the SPM instruction can only execute from there. In ATmega 48A/48PA there is no Read-While-Write support and no separate Boot Loader Section. The SPM instruction can execute from the entire Flash

3. Resources

A comprehensive set of development tools, application notes and datasheets are available for download on <http://www.atmel.com/avr>.

4. Data Retention

Reliability Qualification results show that the projected data retention failure rate is much less than 1 PPM over 20 years at 85°C or 100 years at 25°C.

5. About Code Examples

This documentation contains simple code examples that briefly show how to use various parts of the device. These code examples assume that the part specific header file is included before compilation. Be aware that not all C compiler vendors include bit definitions in the header files and interrupt handling in C is compiler dependent. Please confirm with the C compiler documentation for more details.

For I/O Registers located in extended I/O map, “IN”, “OUT”, “SBIS”, “SBIC”, “CBI”, and “SBI” instructions must be replaced with instructions that allow access to extended I/O. Typically “LDS” and “STS” combined with “SBRS”, “SBRC”, “SBR”, and “CBR”.

6. Capacitive Touch Sensing

The Atmel® QTouch® Library provides a simple to use solution to realize touch sensitive interfaces on most Atmel AVR® microcontrollers. The QTouch Library includes support for the Atmel QTouch and Atmel QMatrix® acquisition methods.

Touch sensing can be added to any application by linking the appropriate Atmel QTouch Library for the AVR Microcontroller. This is done by using a simple set of APIs to define the touch channels and sensors, and then calling the touch sensing APIs to retrieve the channel information and determine the touch sensor states.

The QTouch Library is FREE and downloadable from the Atmel website at the following location: www.atmel.com/qtouchlibrary. For implementation details and other information, refer to the [Atmel QTouch Library User Guide](#) - also available for download from Atmel website.

7. Register Summary

Address	Name	Bit 7	Bit 6	Bit 5	Bit 4	Bit 3	Bit 2	Bit 1	Bit 0	Page
(0xFF)	Reserved	--	--	--	--	--	--	--	--	
(0xFE)	Reserved	--	--	--	--	--	--	--	--	
(0xFD)	Reserved	--	--	--	--	--	--	--	--	
(0xFC)	Reserved	--	--	--	--	--	--	--	--	
(0xFB)	Reserved	--	--	--	--	--	--	--	--	
(0xFA)	Reserved	--	--	--	--	--	--	--	--	
(0xF9)	Reserved	--	--	--	--	--	--	--	--	
(0xF8)	Reserved	--	--	--	--	--	--	--	--	
(0xF7)	Reserved	--	--	--	--	--	--	--	--	
(0xF6)	Reserved	--	--	--	--	--	--	--	--	
(0xF5)	Reserved	--	--	--	--	--	--	--	--	
(0xF4)	Reserved	--	--	--	--	--	--	--	--	
(0xF3)	Reserved	--	--	--	--	--	--	--	--	
(0xF2)	Reserved	--	--	--	--	--	--	--	--	
(0xF1)	Reserved	--	--	--	--	--	--	--	--	
(0xF0)	Reserved	--	--	--	--	--	--	--	--	
(0xEF)	Reserved	--	--	--	--	--	--	--	--	
(0xEE)	Reserved	--	--	--	--	--	--	--	--	
(0xED)	Reserved	--	--	--	--	--	--	--	--	
(0xEC)	Reserved	--	--	--	--	--	--	--	--	
(0xEB)	Reserved	--	--	--	--	--	--	--	--	
(0xEA)	Reserved	--	--	--	--	--	--	--	--	
(0xE9)	Reserved	--	--	--	--	--	--	--	--	
(0xE8)	Reserved	--	--	--	--	--	--	--	--	
(0xE7)	Reserved	--	--	--	--	--	--	--	--	
(0xE6)	Reserved	--	--	--	--	--	--	--	--	
(0xE5)	Reserved	--	--	--	--	--	--	--	--	
(0xE4)	Reserved	--	--	--	--	--	--	--	--	
(0xE3)	Reserved	--	--	--	--	--	--	--	--	
(0xE2)	Reserved	--	--	--	--	--	--	--	--	
(0xE1)	Reserved	--	--	--	--	--	--	--	--	
(0xE0)	Reserved	--	--	--	--	--	--	--	--	
(0xDF)	Reserved	--	--	--	--	--	--	--	--	
(0xDE)	Reserved	--	--	--	--	--	--	--	--	
(0xDD)	Reserved	--	--	--	--	--	--	--	--	
(0xDC)	Reserved	--	--	--	--	--	--	--	--	
(0xDB)	Reserved	--	--	--	--	--	--	--	--	
(0xDA)	Reserved	--	--	--	--	--	--	--	--	
(0xD9)	Reserved	--	--	--	--	--	--	--	--	
(0xD8)	Reserved	--	--	--	--	--	--	--	--	
(0xD7)	Reserved	--	--	--	--	--	--	--	--	
(0xD6)	Reserved	--	--	--	--	--	--	--	--	
(0xD5)	Reserved	--	--	--	--	--	--	--	--	
(0xD4)	Reserved	--	--	--	--	--	--	--	--	
(0xD3)	Reserved	--	--	--	--	--	--	--	--	
(0xD2)	Reserved	--	--	--	--	--	--	--	--	
(0xD1)	Reserved	--	--	--	--	--	--	--	--	
(0xD0)	Reserved	--	--	--	--	--	--	--	--	
(0xCF)	Reserved	--	--	--	--	--	--	--	--	
(0xCE)	Reserved	--	--	--	--	--	--	--	--	
(0xCD)	Reserved	--	--	--	--	--	--	--	--	
(0xCC)	Reserved	--	--	--	--	--	--	--	--	
(0xCB)	Reserved	--	--	--	--	--	--	--	--	
(0xCA)	Reserved	--	--	--	--	--	--	--	--	
(0xC9)	Reserved	--	--	--	--	--	--	--	--	
(0xC8)	Reserved	--	--	--	--	--	--	--	--	
(0xC7)	Reserved	--	--	--	--	--	--	--	--	
(0xC6)	UDR0	USART I/O Data Register								191
(0xC5)	UBRR0H	USART Baud Rate Register High								195
(0xC4)	UBRR0L	USART Baud Rate Register Low								195
(0xC3)	Reserved	--	--	--	--	--	--	--	--	
(0xC2)	UCSR0C	UMSEL01	UMSEL00	UPM01	UPM00	USBS0	UCSZ01 / UDORD0	UCSZ00 / UCPHA0	UCPOL0	193/204
(0xC1)	UCSR0B	RXCIE0	TXCIE0	UDRIE0	RXEN0	TXEN0	UCSZ02	RXB80	TXB80	192

Address	Name	Bit 7	Bit 6	Bit 5	Bit 4	Bit 3	Bit 2	Bit 1	Bit 0	Page
(0xC0)	UCSR0A	RXC0	TXC0	UDRE0	FE0	DOR0	UPF0	U2X0	MPCM0	191
(0xBF)	Reserved	–	–	–	–	–	–	–	–	
(0xBE)	Reserved	–	–	–	–	–	–	–	–	
(0xBD)	TWAMR	TWAM6	TWAM5	TWAM4	TWAM3	TWAM2	TWAM1	TWAM0	–	233
(0xBC)	TWCR	TWINT	TWEA	TWSTA	TWSTO	TWWC	TWEN	–	TWIE	230
(0xBB)	TWDR	2-wire Serial Interface Data Register								232
(0xBA)	TWAR	TWA6	TWA5	TWA4	TWA3	TWA2	TWA1	TWA0	TWGCE	232
(0xB9)	TWSR	TWS7	TWS6	TWS5	TWS4	TWS3	–	TWPS1	TWPS0	231
(0xB8)	TWBR	2-wire Serial Interface Bit Rate Register								230
(0xB7)	Reserved	–	–	–	–	–	–	–	–	
(0xB6)	ASSR	–	EXCLK	AS2	TCN2UB	OCR2AUB	OCR2BUB	TCR2AUB	TCR2BUB	158
(0xB5)	Reserved	–	–	–	–	–	–	–	–	
(0xB4)	OCR2B	Timer/Counter2 Output Compare Register B								157
(0xB3)	OCR2A	Timer/Counter2 Output Compare Register A								157
(0xB2)	TCNT2	Timer/Counter2 (8-bit)								157
(0xB1)	TCCR2B	FOC2A	FOC2B	–	–	WGM22	CS22	CS21	CS20	156
(0xB0)	TCCR2A	COM2A1	COM2A0	COM2B1	COM2B0	–	–	WGM21	WGM20	153
(0xAF)	Reserved	–	–	–	–	–	–	–	–	
(0xAE)	Reserved	–	–	–	–	–	–	–	–	
(0xAD)	Reserved	–	–	–	–	–	–	–	–	
(0xAC)	Reserved	–	–	–	–	–	–	–	–	
(0xAB)	Reserved	–	–	–	–	–	–	–	–	
(0xAA)	Reserved	–	–	–	–	–	–	–	–	
(0xA9)	Reserved	–	–	–	–	–	–	–	–	
(0xA8)	Reserved	–	–	–	–	–	–	–	–	
(0xA7)	Reserved	–	–	–	–	–	–	–	–	
(0xA6)	Reserved	–	–	–	–	–	–	–	–	
(0xA5)	Reserved	–	–	–	–	–	–	–	–	
(0xA4)	Reserved	–	–	–	–	–	–	–	–	
(0xA3)	Reserved	–	–	–	–	–	–	–	–	
(0xA2)	Reserved	–	–	–	–	–	–	–	–	
(0xA1)	Reserved	–	–	–	–	–	–	–	–	
(0xA0)	Reserved	–	–	–	–	–	–	–	–	
(0x9F)	Reserved	–	–	–	–	–	–	–	–	
(0x9E)	Reserved	–	–	–	–	–	–	–	–	
(0x9D)	Reserved	–	–	–	–	–	–	–	–	
(0x9C)	Reserved	–	–	–	–	–	–	–	–	
(0x9B)	Reserved	–	–	–	–	–	–	–	–	
(0x9A)	Reserved	–	–	–	–	–	–	–	–	
(0x99)	Reserved	–	–	–	–	–	–	–	–	
(0x98)	Reserved	–	–	–	–	–	–	–	–	
(0x97)	Reserved	–	–	–	–	–	–	–	–	
(0x96)	Reserved	–	–	–	–	–	–	–	–	
(0x95)	Reserved	–	–	–	–	–	–	–	–	
(0x94)	Reserved	–	–	–	–	–	–	–	–	
(0x93)	Reserved	–	–	–	–	–	–	–	–	
(0x92)	Reserved	–	–	–	–	–	–	–	–	
(0x91)	Reserved	–	–	–	–	–	–	–	–	
(0x90)	Reserved	–	–	–	–	–	–	–	–	
(0x8F)	Reserved	–	–	–	–	–	–	–	–	
(0x8E)	Reserved	–	–	–	–	–	–	–	–	
(0x8D)	Reserved	–	–	–	–	–	–	–	–	
(0x8C)	Reserved	–	–	–	–	–	–	–	–	
(0x8B)	OCR1BH	Timer/Counter1 - Output Compare Register B High Byte								135
(0x8A)	OCR1BL	Timer/Counter1 - Output Compare Register B Low Byte								135
(0x89)	OCR1AH	Timer/Counter1 - Output Compare Register A High Byte								135
(0x88)	OCR1AL	Timer/Counter1 - Output Compare Register A Low Byte								135
(0x87)	ICR1H	Timer/Counter1 - Input Capture Register High Byte								135
(0x86)	ICR1L	Timer/Counter1 - Input Capture Register Low Byte								135
(0x85)	TCNT1H	Timer/Counter1 - Counter Register High Byte								134
(0x84)	TCNT1L	Timer/Counter1 - Counter Register Low Byte								134
(0x83)	Reserved	–	–	–	–	–	–	–	–	
(0x82)	TCCR1C	FOC1A	FOC1B	–	–	–	–	–	–	134
(0x81)	TCCR1B	ICNC1	ICES1	–	WGM13	WGM12	CS12	CS11	CS10	133
(0x80)	TCCR1A	COM1A1	COM1A0	COM1B1	COM1B0	–	–	WGM11	WGM10	131
(0x7F)	DIDR1	–	–	–	–	–	–	AIN1D	AIN0D	236
(0x7E)	DIDR0	–	–	ADC5D	ADC4D	ADC3D	ADC2D	ADC1D	ADC0D	251
(0x7D)	Reserved	–	–	–	–	–	–	–	–	

Address	Name	Bit 7	Bit 6	Bit 5	Bit 4	Bit 3	Bit 2	Bit 1	Bit 0	Page
(0x7C)	ADMUX	REFS1	REFS0	ADLAR	–	MUX3	MUX2	MUX1	MUX0	248
(0x7B)	ADCSR	–	ACME	–	–	–	ADTS2	ADTS1	ADTS0	251
(0x7A)	ADCSRA	ADEN	ADSC	ADATE	ADIF	ADIE	ADPS2	ADPS1	ADPS0	249
(0x79)	ADCH	ADC Data Register High byte								250
(0x78)	ADCL	ADC Data Register Low byte								250
(0x77)	Reserved	–	–	–	–	–	–	–	–	
(0x76)	Reserved	–	–	–	–	–	–	–	–	
(0x75)	Reserved	–	–	–	–	–	–	–	–	
(0x74)	Reserved	–	–	–	–	–	–	–	–	
(0x73)	Reserved	–	–	–	–	–	–	–	–	
(0x72)	Reserved	–	–	–	–	–	–	–	–	
(0x71)	Reserved	–	–	–	–	–	–	–	–	
(0x70)	TIMSK2	–	–	–	–	–	OCIE2B	OCIE2A	TOIE2	157
(0x6F)	TIMSK1	–	–	ICIE1	–	–	OCIE1B	OCIE1A	TOIE1	135
(0x6E)	TIMSK0	–	–	–	–	–	OCIE0B	OCIE0A	TOIE0	109
(0x6D)	PCMSK2	PCINT23	PCINT22	PCINT21	PCINT20	PCINT19	PCINT18	PCINT17	PCINT16	74
(0x6C)	PCMSK1	–	PCINT14	PCINT13	PCINT12	PCINT11	PCINT10	PCINT9	PCINT8	74
(0x6B)	PCMSK0	PCINT7	PCINT6	PCINT5	PCINT4	PCINT3	PCINT2	PCINT1	PCINT0	74
(0x6A)	Reserved	–	–	–	–	–	–	–	–	
(0x69)	EICRA	–	–	–	–	ISC11	ISC10	ISC01	ISC00	71
(0x68)	PCICR	–	–	–	–	–	PCIE2	PCIE1	PCIE0	
(0x67)	Reserved	–	–	–	–	–	–	–	–	
(0x66)	OSCCAL	Oscillator Calibration Register								37
(0x65)	Reserved	–	–	–	–	–	–	–	–	
(0x64)	PRR	PRTWI	PRTIM2	PRTIM0	–	PRTIM1	PRSPI	PRUSART0	PRADC	42
(0x63)	Reserved	–	–	–	–	–	–	–	–	
(0x62)	Reserved	–	–	–	–	–	–	–	–	
(0x61)	CLKPR	CLKPCE	–	–	–	CLKPS3	CLKPS2	CLKPS1	CLKPS0	37
(0x60)	WDTCSR	WDIF	WDIE	WDP3	WDCE	WDE	WDP2	WDP1	WDP0	54
0x3F (0x5F)	SREG	I	T	H	S	V	N	Z	C	10
0x3E (0x5E)	SPH	–	–	–	–	–	(SP10) ⁵	SP9	SP8	13
0x3D (0x5D)	SPL	SP7	SP6	SP5	SP4	SP3	SP2	SP1	SP0	13
0x3C (0x5C)	Reserved	–	–	–	–	–	–	–	–	
0x3B (0x5B)	Reserved	–	–	–	–	–	–	–	–	
0x3A (0x5A)	Reserved	–	–	–	–	–	–	–	–	
0x39 (0x59)	Reserved	–	–	–	–	–	–	–	–	
0x38 (0x58)	Reserved	–	–	–	–	–	–	–	–	
0x37 (0x57)	SPMCSR	SPMIE	(RWWSB) ⁵	SIGRD	(RWWRE) ⁵	BLBSET	PGWRT	PGERS	SPMEN	278
0x36 (0x56)	Reserved	–	–	–	–	–	–	–	–	
0x35 (0x55)	MCUCR	–	BODS ⁶	BODSE ⁶	PUD	–	–	IVSEL	IVCE	45/68/91
0x34 (0x54)	MCUSR	–	–	–	–	WDRF	BORF	EXTRF	PORF	54
0x33 (0x53)	SMCR	–	–	–	–	SM2	SM1	SM0	SE	40
0x32 (0x52)	Reserved	–	–	–	–	–	–	–	–	
0x31 (0x51)	Reserved	–	–	–	–	–	–	–	–	
0x30 (0x50)	ACSR	ACD	ACBG	ACO	ACI	ACIE	ACIC	ACIS1	ACIS0	235
0x2F (0x4F)	Reserved	–	–	–	–	–	–	–	–	
0x2E (0x4E)	SPDR	SPI Data Register								169
0x2D (0x4D)	SPSR	SPIF	WCOL	–	–	–	–	–	SPI2X	168
0x2C (0x4C)	SPCR	SPIE	SPE	DORD	MSTR	CPOL	CPHA	SPR1	SPR0	167
0x2B (0x4B)	GPIOR2	General Purpose I/O Register 2								26
0x2A (0x4A)	GPIOR1	General Purpose I/O Register 1								26
0x29 (0x49)	Reserved	–	–	–	–	–	–	–	–	
0x28 (0x48)	OCR0B	Timer/Counter0 Output Compare Register B								
0x27 (0x47)	OCR0A	Timer/Counter0 Output Compare Register A								
0x26 (0x46)	TCNT0	Timer/Counter0 (8-bit)								
0x25 (0x45)	TCCR0B	FOC0A	FOC0B	–	–	WGM02	CS02	CS01	CS00	
0x24 (0x44)	TCCR0A	COM0A1	COM0A0	COM0B1	COM0B0	–	–	WGM01	WGM00	
0x23 (0x43)	GTCCR	TSM	–	–	–	–	–	PSRASY	PSRSYNC	140/159
0x22 (0x42)	EEARH	(EEPROM Address Register High Byte) ⁵								22
0x21 (0x41)	EEARL	EEPROM Address Register Low Byte								22
0x20 (0x40)	EEDR	EEPROM Data Register								22
0x1F (0x3F)	EECR	–	–	EEMP1	EEMP0	EERIE	EEMPE	EEPE	EERE	22
0x1E (0x3E)	GPIOR0	General Purpose I/O Register 0								26
0x1D (0x3D)	EIMSK	–	–	–	–	–	–	INT1	INT0	72
0x1C (0x3C)	EIFR	–	–	–	–	–	–	INTF1	INTF0	72
0x1B (0x3B)	PCIFR	–	–	–	–	–	PCIF2	PCIF1	PCIF0	
0x1A (0x3A)	Reserved	–	–	–	–	–	–	–	–	
0x19 (0x39)	Reserved	–	–	–	–	–	–	–	–	

Address	Name	Bit 7	Bit 6	Bit 5	Bit 4	Bit 3	Bit 2	Bit 1	Bit 0	Page
0x18 (0x38)	Reserved	–	–	–	–	–	–	–	–	
0x17 (0x37)	TIFR2	–	–	–	–	–	OCF2B	OCF2A	TOV2	158
0x16 (0x36)	TIFR1	–	–	ICF1	–	–	OCF1B	OCF1A	TOV1	136
0x15 (0x35)	TIFR0	–	–	–	–	–	OCF0B	OCF0A	TOV0	
0x14 (0x34)	Reserved	–	–	–	–	–	–	–	–	
0x13 (0x33)	Reserved	–	–	–	–	–	–	–	–	
0x12 (0x32)	Reserved	–	–	–	–	–	–	–	–	
0x11 (0x31)	Reserved	–	–	–	–	–	–	–	–	
0x10 (0x30)	Reserved	–	–	–	–	–	–	–	–	
0x0F (0x2F)	Reserved	–	–	–	–	–	–	–	–	
0x0E (0x2E)	Reserved	–	–	–	–	–	–	–	–	
0x0D (0x2D)	Reserved	–	–	–	–	–	–	–	–	
0x0C (0x2C)	Reserved	–	–	–	–	–	–	–	–	
0x0B (0x2B)	PORTD	PORTD7	PORTD6	PORTD5	PORTD4	PORTD3	PORTD2	PORTD1	PORTD0	92
0x0A (0x2A)	DDRD	DDD7	DDD6	DDD5	DDD4	DDD3	DDD2	DDD1	DDD0	92
0x09 (0x29)	PIND	PIND7	PIND6	PIND5	PIND4	PIND3	PIND2	PIND1	PIND0	92
0x08 (0x28)	PORTC	–	PORTC6	PORTC5	PORTC4	PORTC3	PORTC2	PORTC1	PORTC0	91
0x07 (0x27)	DDRC	–	DDC6	DDC5	DDC4	DDC3	DDC2	DDC1	DDC0	91
0x06 (0x26)	PINC	–	PINC6	PINC5	PINC4	PINC3	PINC2	PINC1	PINC0	92
0x05 (0x25)	PORTB	PORTB7	PORTB6	PORTB5	PORTB4	PORTB3	PORTB2	PORTB1	PORTB0	91
0x04 (0x24)	DDRB	DDB7	DDB6	DDB5	DDB4	DDB3	DDB2	DDB1	DDB0	91
0x03 (0x23)	PINB	PINB7	PINB6	PINB5	PINB4	PINB3	PINB2	PINB1	PINB0	91
0x02 (0x22)	Reserved	–	–	–	–	–	–	–	–	
0x01 (0x21)	Reserved	–	–	–	–	–	–	–	–	
0x0 (0x20)	Reserved	–	–	–	–	–	–	–	–	

- Note:
1. For compatibility with future devices, reserved bits should be written to zero if accessed. Reserved I/O memory addresses should never be written.
 2. I/O Registers within the address range 0x00 - 0x1F are directly bit-accessible using the SBI and CBI instructions. In these registers, the value of single bits can be checked by using the SBIS and SBIC instructions.
 3. Some of the Status Flags are cleared by writing a logical one to them. Note that, unlike most other AVRs, the CBI and SBI instructions will only operate on the specified bit, and can therefore be used on registers containing such Status Flags. The CBI and SBI instructions work with registers 0x00 to 0x1F only.
 4. When using the I/O specific commands IN and OUT, the I/O addresses 0x00 - 0x3F must be used. When addressing I/O Registers as data space using LD and ST instructions, 0x20 must be added to these addresses. The ATmega48A/PA/88A/PA/168A/PA/328/P is a complex microcontroller with more peripheral units than can be supported within the 64 location reserved in Opcode for the IN and OUT instructions. For the Extended I/O space from 0x60 - 0xFF in SRAM, only the ST/STS/STD and LD/LDS/LDD instructions can be used.
 5. Only valid for ATmega88A/88PA/168A/168PA/328/328P.
 6. BODS and BODSE only available for picoPower devices ATmega48PA/88PA/168PA/328P

8. Instruction Set Summary

Mnemonics	Operands	Description	Operation	Flags	#Clocks
ARITHMETIC AND LOGIC INSTRUCTIONS					
ADD	Rd, Rr	Add two Registers	$Rd \leftarrow Rd + Rr$	Z,C,N,V,H	1
ADC	Rd, Rr	Add with Carry two Registers	$Rd \leftarrow Rd + Rr + C$	Z,C,N,V,H	1
ADIW	RdI,K	Add Immediate to Word	$Rdh:Rdl \leftarrow Rdh:Rdl + K$	Z,C,N,V,S	2
SUB	Rd, Rr	Subtract two Registers	$Rd \leftarrow Rd - Rr$	Z,C,N,V,H	1
SUBI	Rd, K	Subtract Constant from Register	$Rd \leftarrow Rd - K$	Z,C,N,V,H	1
SBC	Rd, Rr	Subtract with Carry two Registers	$Rd \leftarrow Rd - Rr - C$	Z,C,N,V,H	1
SBCI	Rd, K	Subtract with Carry Constant from Reg.	$Rd \leftarrow Rd - K - C$	Z,C,N,V,H	1
SBIW	RdI,K	Subtract Immediate from Word	$Rdh:Rdl \leftarrow Rdh:Rdl - K$	Z,C,N,V,S	2
AND	Rd, Rr	Logical AND Registers	$Rd \leftarrow Rd \bullet Rr$	Z,N,V	1
ANDI	Rd, K	Logical AND Register and Constant	$Rd \leftarrow Rd \bullet K$	Z,N,V	1
OR	Rd, Rr	Logical OR Registers	$Rd \leftarrow Rd \vee Rr$	Z,N,V	1
ORI	Rd, K	Logical OR Register and Constant	$Rd \leftarrow Rd \vee K$	Z,N,V	1
EOR	Rd, Rr	Exclusive OR Registers	$Rd \leftarrow Rd \oplus Rr$	Z,N,V	1
COM	Rd	One's Complement	$Rd \leftarrow 0xFF - Rd$	Z,C,N,V	1
NEG	Rd	Two's Complement	$Rd \leftarrow 0x00 - Rd$	Z,C,N,V,H	1
SBR	Rd,K	Set Bit(s) in Register	$Rd \leftarrow Rd \vee K$	Z,N,V	1
CBR	Rd,K	Clear Bit(s) in Register	$Rd \leftarrow Rd \bullet (0xFF - K)$	Z,N,V	1
INC	Rd	Increment	$Rd \leftarrow Rd + 1$	Z,N,V	1
DEC	Rd	Decrement	$Rd \leftarrow Rd - 1$	Z,N,V	1
TST	Rd	Test for Zero or Minus	$Rd \leftarrow Rd \bullet Rd$	Z,N,V	1
CLR	Rd	Clear Register	$Rd \leftarrow Rd \oplus Rd$	Z,N,V	1
SER	Rd	Set Register	$Rd \leftarrow 0xFF$	None	1
MUL	Rd, Rr	Multiply Unsigned	$R1:R0 \leftarrow Rd \times Rr$	Z,C	2
MULS	Rd, Rr	Multiply Signed	$R1:R0 \leftarrow Rd \times Rr$	Z,C	2
MULSU	Rd, Rr	Multiply Signed with Unsigned	$R1:R0 \leftarrow Rd \times Rr$	Z,C	2
FMUL	Rd, Rr	Fractional Multiply Unsigned	$R1:R0 \leftarrow (Rd \times Rr) \ll 1$	Z,C	2
FMULS	Rd, Rr	Fractional Multiply Signed	$R1:R0 \leftarrow (Rd \times Rr) \ll 1$	Z,C	2
FMULSU	Rd, Rr	Fractional Multiply Signed with Unsigned	$R1:R0 \leftarrow (Rd \times Rr) \ll 1$	Z,C	2
BRANCH INSTRUCTIONS					
RJMP	k	Relative Jump	$PC \leftarrow PC + k + 1$	None	2
IJMP		Indirect Jump to (Z)	$PC \leftarrow Z$	None	2
JMP ⁽¹⁾	k	Direct Jump	$PC \leftarrow k$	None	3
RCALL	k	Relative Subroutine Call	$PC \leftarrow PC + k + 1$	None	3
ICALL		Indirect Call to (Z)	$PC \leftarrow Z$	None	3
CALL ⁽¹⁾	k	Direct Subroutine Call	$PC \leftarrow k$	None	4
RET		Subroutine Return	$PC \leftarrow STACK$	None	4
RETI		Interrupt Return	$PC \leftarrow STACK$	I	4
CPSE	Rd,Rr	Compare, Skip if Equal	if $(Rd = Rr)$ $PC \leftarrow PC + 2$ or 3	None	1/2/3
CP	Rd,Rr	Compare	$Rd - Rr$	Z, N,V,C,H	1
CPC	Rd,Rr	Compare with Carry	$Rd - Rr - C$	Z, N,V,C,H	1
CPI	Rd,K	Compare Register with Immediate	$Rd - K$	Z, N,V,C,H	1
SBRC	Rr, b	Skip if Bit in Register Cleared	if $(Rr(b)=0)$ $PC \leftarrow PC + 2$ or 3	None	1/2/3
SBRS	Rr, b	Skip if Bit in Register is Set	if $(Rr(b)=1)$ $PC \leftarrow PC + 2$ or 3	None	1/2/3
SBIC	P, b	Skip if Bit in I/O Register Cleared	if $(P(b)=0)$ $PC \leftarrow PC + 2$ or 3	None	1/2/3
SBIS	P, b	Skip if Bit in I/O Register is Set	if $(P(b)=1)$ $PC \leftarrow PC + 2$ or 3	None	1/2/3
BRBS	s, k	Branch if Status Flag Set	if $(SREG(s) = 1)$ then $PC \leftarrow PC + k + 1$	None	1/2
BRBC	s, k	Branch if Status Flag Cleared	if $(SREG(s) = 0)$ then $PC \leftarrow PC + k + 1$	None	1/2
BREQ	k	Branch if Equal	if $(Z = 1)$ then $PC \leftarrow PC + k + 1$	None	1/2
BRNE	k	Branch if Not Equal	if $(Z = 0)$ then $PC \leftarrow PC + k + 1$	None	1/2
BRCS	k	Branch if Carry Set	if $(C = 1)$ then $PC \leftarrow PC + k + 1$	None	1/2
BRCC	k	Branch if Carry Cleared	if $(C = 0)$ then $PC \leftarrow PC + k + 1$	None	1/2
BRSH	k	Branch if Same or Higher	if $(C = 0)$ then $PC \leftarrow PC + k + 1$	None	1/2
BRLO	k	Branch if Lower	if $(C = 1)$ then $PC \leftarrow PC + k + 1$	None	1/2
BRMI	k	Branch if Minus	if $(N = 1)$ then $PC \leftarrow PC + k + 1$	None	1/2
BRPL	k	Branch if Plus	if $(N = 0)$ then $PC \leftarrow PC + k + 1$	None	1/2
BRGE	k	Branch if Greater or Equal, Signed	if $(N \oplus V = 0)$ then $PC \leftarrow PC + k + 1$	None	1/2
BRLT	k	Branch if Less Than Zero, Signed	if $(N \oplus V = 1)$ then $PC \leftarrow PC + k + 1$	None	1/2
BRHS	k	Branch if Half Carry Flag Set	if $(H = 1)$ then $PC \leftarrow PC + k + 1$	None	1/2
BRHC	k	Branch if Half Carry Flag Cleared	if $(H = 0)$ then $PC \leftarrow PC + k + 1$	None	1/2
BRTS	k	Branch if T Flag Set	if $(T = 1)$ then $PC \leftarrow PC + k + 1$	None	1/2
BRTC	k	Branch if T Flag Cleared	if $(T = 0)$ then $PC \leftarrow PC + k + 1$	None	1/2
BRVS	k	Branch if Overflow Flag is Set	if $(V = 1)$ then $PC \leftarrow PC + k + 1$	None	1/2
BRVC	k	Branch if Overflow Flag is Cleared	if $(V = 0)$ then $PC \leftarrow PC + k + 1$	None	1/2
BRIE	k	Branch if Interrupt Enabled	if $(I = 1)$ then $PC \leftarrow PC + k + 1$	None	1/2
BRID	k	Branch if Interrupt Disabled	if $(I = 0)$ then $PC \leftarrow PC + k + 1$	None	1/2

Mnemonics	Operands	Description	Operation	Flags	#Clocks
BIT AND BIT-TEST INSTRUCTIONS					
SBI	P,b	Set Bit in I/O Register	$I/O(P,b) \leftarrow 1$	None	2
CBI	P,b	Clear Bit in I/O Register	$I/O(P,b) \leftarrow 0$	None	2
LSL	Rd	Logical Shift Left	$Rd(n+1) \leftarrow Rd(n), Rd(0) \leftarrow 0$	Z,C,N,V	1
LSR	Rd	Logical Shift Right	$Rd(n) \leftarrow Rd(n+1), Rd(7) \leftarrow 0$	Z,C,N,V	1
ROL	Rd	Rotate Left Through Carry	$Rd(0) \leftarrow C, Rd(n+1) \leftarrow Rd(n), C \leftarrow Rd(7)$	Z,C,N,V	1
ROR	Rd	Rotate Right Through Carry	$Rd(7) \leftarrow C, Rd(n) \leftarrow Rd(n+1), C \leftarrow Rd(0)$	Z,C,N,V	1
ASR	Rd	Arithmetic Shift Right	$Rd(n) \leftarrow Rd(n+1), n=0..6$	Z,C,N,V	1
SWAP	Rd	Swap Nibbles	$Rd(3..0) \leftarrow Rd(7..4), Rd(7..4) \leftarrow Rd(3..0)$	None	1
BSET	s	Flag Set	$SREG(s) \leftarrow 1$	SREG(s)	1
BCLR	s	Flag Clear	$SREG(s) \leftarrow 0$	SREG(s)	1
BST	Rr, b	Bit Store from Register to T	$T \leftarrow Rr(b)$	T	1
BLD	Rd, b	Bit load from T to Register	$Rd(b) \leftarrow T$	None	1
SEC		Set Carry	$C \leftarrow 1$	C	1
CLC		Clear Carry	$C \leftarrow 0$	C	1
SEN		Set Negative Flag	$N \leftarrow 1$	N	1
CLN		Clear Negative Flag	$N \leftarrow 0$	N	1
SEZ		Set Zero Flag	$Z \leftarrow 1$	Z	1
CLZ		Clear Zero Flag	$Z \leftarrow 0$	Z	1
SEI		Global Interrupt Enable	$I \leftarrow 1$	I	1
CLI		Global Interrupt Disable	$I \leftarrow 0$	I	1
SES		Set Signed Test Flag	$S \leftarrow 1$	S	1
CLS		Clear Signed Test Flag	$S \leftarrow 0$	S	1
SEV		Set Twos Complement Overflow.	$V \leftarrow 1$	V	1
CLV		Clear Twos Complement Overflow	$V \leftarrow 0$	V	1
SET		Set T in SREG	$T \leftarrow 1$	T	1
CLT		Clear T in SREG	$T \leftarrow 0$	T	1
SEH		Set Half Carry Flag in SREG	$H \leftarrow 1$	H	1
CLH		Clear Half Carry Flag in SREG	$H \leftarrow 0$	H	1
DATA TRANSFER INSTRUCTIONS					
MOV	Rd, Rr	Move Between Registers	$Rd \leftarrow Rr$	None	1
MOVW	Rd, Rr	Copy Register Word	$Rd+1:Rd \leftarrow Rr+1:Rr$	None	1
LDI	Rd, K	Load Immediate	$Rd \leftarrow K$	None	1
LD	Rd, X	Load Indirect	$Rd \leftarrow (X)$	None	2
LD	Rd, X+	Load Indirect and Post-Inc.	$Rd \leftarrow (X), X \leftarrow X + 1$	None	2
LD	Rd, -X	Load Indirect and Pre-Dec.	$X \leftarrow X - 1, Rd \leftarrow (X)$	None	2
LD	Rd, Y	Load Indirect	$Rd \leftarrow (Y)$	None	2
LD	Rd, Y+	Load Indirect and Post-Inc.	$Rd \leftarrow (Y), Y \leftarrow Y + 1$	None	2
LD	Rd, -Y	Load Indirect and Pre-Dec.	$Y \leftarrow Y - 1, Rd \leftarrow (Y)$	None	2
LDD	Rd, Y+q	Load Indirect with Displacement	$Rd \leftarrow (Y + q)$	None	2
LD	Rd, Z	Load Indirect	$Rd \leftarrow (Z)$	None	2
LD	Rd, Z+	Load Indirect and Post-Inc.	$Rd \leftarrow (Z), Z \leftarrow Z + 1$	None	2
LD	Rd, -Z	Load Indirect and Pre-Dec.	$Z \leftarrow Z - 1, Rd \leftarrow (Z)$	None	2
LDD	Rd, Z+q	Load Indirect with Displacement	$Rd \leftarrow (Z + q)$	None	2
LDS	Rd, k	Load Direct from SRAM	$Rd \leftarrow (k)$	None	2
ST	X, Rr	Store Indirect	$(X) \leftarrow Rr$	None	2
ST	X+, Rr	Store Indirect and Post-Inc.	$(X) \leftarrow Rr, X \leftarrow X + 1$	None	2
ST	-X, Rr	Store Indirect and Pre-Dec.	$X \leftarrow X - 1, (X) \leftarrow Rr$	None	2
ST	Y, Rr	Store Indirect	$(Y) \leftarrow Rr$	None	2
ST	Y+, Rr	Store Indirect and Post-Inc.	$(Y) \leftarrow Rr, Y \leftarrow Y + 1$	None	2
ST	-Y, Rr	Store Indirect and Pre-Dec.	$Y \leftarrow Y - 1, (Y) \leftarrow Rr$	None	2
STD	Y+q, Rr	Store Indirect with Displacement	$(Y + q) \leftarrow Rr$	None	2
ST	Z, Rr	Store Indirect	$(Z) \leftarrow Rr$	None	2
ST	Z+, Rr	Store Indirect and Post-Inc.	$(Z) \leftarrow Rr, Z \leftarrow Z + 1$	None	2
ST	-Z, Rr	Store Indirect and Pre-Dec.	$Z \leftarrow Z - 1, (Z) \leftarrow Rr$	None	2
STD	Z+q, Rr	Store Indirect with Displacement	$(Z + q) \leftarrow Rr$	None	2
STS	k, Rr	Store Direct to SRAM	$(k) \leftarrow Rr$	None	2
LPM		Load Program Memory	$R0 \leftarrow (Z)$	None	3
LPM	Rd, Z	Load Program Memory	$Rd \leftarrow (Z)$	None	3
LPM	Rd, Z+	Load Program Memory and Post-Inc	$Rd \leftarrow (Z), Z \leftarrow Z + 1$	None	3
SPM		Store Program Memory	$(Z) \leftarrow R1:R0$	None	-
IN	Rd, P	In Port	$Rd \leftarrow P$	None	1
OUT	P, Rr	Out Port	$P \leftarrow Rr$	None	1
PUSH	Rr	Push Register on Stack	$STACK \leftarrow Rr$	None	2
POP	Rd	Pop Register from Stack	$Rd \leftarrow STACK$	None	2
MCU CONTROL INSTRUCTIONS					
NOP		No Operation		None	1
SLEEP		Sleep	(see specific descr. for Sleep function)	None	1

Mnemonics	Operands	Description	Operation	Flags	#Clocks
WDR		Watchdog Reset	(see specific descr. for WDR/timer)	None	1
BREAK		Break	For On-chip Debug Only	None	N/A

Note: 1. These instructions are only available in ATmega168PA and ATmega328P.

9. Ordering Information

9.1 ATmega48A

Speed (MHz)	Power Supply (V)	Ordering Code ⁽²⁾	Package ⁽¹⁾	Operational Range ⁽⁶⁾
20 ⁽³⁾	1.8 - 5.5	ATmega48A-AU ATmega48A-AUR ⁽⁵⁾ ATmega48A-CCU ATmega48A-CCUR ⁽⁵⁾ ATmega48A-MMH ⁽⁴⁾ ATmega48A-MMHR ⁽⁴⁾⁽⁵⁾ ATmega48A-MU ATmega48A-MUR ⁽⁵⁾ ATmega48A-PU	32A 32A 32CC1 32CC1 28M1 28M1 32M1-A 32M1-A 28P3	Industrial (-40°C to 85°C)

- Note:
1. This device can also be supplied in wafer form. Please contact your local Atmel sales office for detailed ordering information and minimum quantities.
 2. Pb-free packaging complies to the European Directive for Restriction of Hazardous Substances (RoHS directive). Also Halide free and fully Green.
 3. See "Speed Grades" on page 303.
 4. NiPdAu Lead Finish.
 5. Tape & Reel.
 6. Use "ATmega48PA" on page 17, industrial (-40°C to 105°C) as the ATmega48A (-40°C to 105°C) is not presently offered.

	32-lead, Thin (1.0 mm) Plastic Quad Flat Package (TQFP)
	32-ball, 4 x 4 x 0.6 mm package, ball pitch 0.5 mm, Ultra Thin, Fine-Pitch Ball Grid Array (UFBGA)
	28-pad, 4 x 4 x 1.0 body, Lead Pitch 0.45 mm Quad Flat No-Lead/Micro Lead Frame Package (QFN/MLF)
	32-pad, 5 x 5 x 1.0 body, Lead Pitch 0.50 mm Quad Flat No-Lead/Micro Lead Frame Package (QFN/MLF)
	28-lead, 0.300" Wide, Plastic Dual Inline Package (PDIP)

9.2 ATmega48PA

Speed (MHz) ⁽³⁾	Power Supply (V)	Ordering Code ⁽²⁾	Package ⁽¹⁾	Operational Range
20	1.8 - 5.5	ATmega48PA-AU	32A	Industrial (-40°C to 85°C)
		ATmega48PA-AUR ⁽⁵⁾	32A	
		ATmega48PA-CCU	32CC1	
		ATmega48PA-CCUR ⁽⁵⁾	32CC1	
		ATmega48PA-MMH ⁽⁴⁾	28M1	
		ATmega48PA-MMHR ⁽⁴⁾⁽⁵⁾	28M1	
		ATmega48PA-MU	32M1-A	
		ATmega48PA-MUR ⁽⁵⁾	32M1-A	
		ATmega48PA-PU	28P3	
		ATmega48PA-AN	32A	Industrial (-40°C to 105°C)
		ATmega48PA-ANR ⁽⁵⁾	32A	
		ATmega48PA-MMN ⁽⁴⁾	28M1	
		ATmega48PA-MMNR ⁽⁴⁾⁽⁵⁾	28M1	
		ATmega48PA-MN	32M1-A	
		ATmega48PA-MNR ⁽⁵⁾	32M1-A	
ATmega48PA-PN	28P3			

- Note:
1. This device can also be supplied in wafer form. Please contact your local Atmel sales office for detailed ordering information and minimum quantities.
 2. Pb-free packaging complies to the European Directive for Restriction of Hazardous Substances (RoHS directive). Also Halide free and fully Green.
 3. See "Speed Grades" on page 303.
 4. NiPdAu Lead Finish.
 5. Tape & Reel.

	32-lead, Thin (1.0mm) Plastic Quad Flat Package (TQFP)
	32-ball, 4 x 4 x 0.6mm package, ball pitch 0.5mm, Ultra Thin, Fine-Pitch Ball Grill Array (UFBGA)
	28-pad, 4 x 4 x 1.0 body, Lead Pitch 0.45mm Quad Flat No-Lead/Micro Lead Frame Package (QFN/MLF)
	32-pad, 5 x 5 x 1.0 body, Lead Pitch 0.50mm Quad Flat No-Lead/Micro Lead Frame Package (QFN/MLF)
	28-lead, 0.300" Wide, Plastic Dual Inline Package (PDIP)

9.3 ATmega88A

Speed (MHz)	Power Supply (V)	Ordering Code ⁽²⁾	Package ⁽¹⁾	Operational Range ⁽⁶⁾
20 ⁽³⁾	1.8 - 5.5	ATmega88A-AU ATmega88A-AUR ⁽⁵⁾ ATmega88A-CCU ATmega88A-CCUR ⁽⁵⁾ ATmega88A-MMH ⁽⁴⁾ ATmega88A-MMHR ⁽⁴⁾⁽⁵⁾ ATmega88A-MU ATmega88A-MUR ⁽⁵⁾ ATmega88A-PU	32A 32A 32CC1 32CC1 28M1 28M1 32M1-A 32M1-A 28P3	Industrial (-40°C to 85°C)

- Note:
1. This device can also be supplied in wafer form. Please contact your local Atmel sales office for detailed ordering information and minimum quantities.
 2. Pb-free packaging complies to the European Directive for Restriction of Hazardous Substances (RoHS directive). Also Halide free and fully Green.
 3. See "Speed Grades" on page 303.
 4. NiPdAu Lead Finish.
 5. Tape & Reel.
 6. Use "ATmega88PA" on page 19, industrial (-40°C to 105°C) as the ATmega48A (-40°C to 105°C) is not presently offered.

	32-lead, Thin (1.0mm) Plastic Quad Flat Package (TQFP)
	32-ball, 4 x 4 x 0.6mm package, ball pitch 0.5mm, Ultra Thin, Fine-Pitch Ball Grid Array (UFPGA)
	28-pad, 4 x 4 x 1.0 body, Lead Pitch 0.45mm Quad Flat No-Lead/Micro Lead Frame Package (QFN/MLF)
	32-pad, 5 x 5 x 1.0 body, Lead Pitch 0.50mm Quad Flat No-Lead/Micro Lead Frame Package (QFN/MLF)
	28-lead, 0.300" Wide, Plastic Dual Inline Package (PDIP)

9.4 ATmega88PA

Speed (MHz) ⁽³⁾	Power Supply (V)	Ordering Code ⁽²⁾	Package ⁽¹⁾	Operational Range
20	1.8 - 5.5	ATmega88PA-AU	32A	Industrial (-40°C to 85°C)
		ATmega88PA-AUR ⁽⁵⁾	32A	
		ATmega88PA-CCU	32CC1	
		ATmega88PA-CCUR ⁽⁵⁾	32CC1	
		ATmega88PA-MMH ⁽⁴⁾	28M1	
		ATmega88PA-MMHR ⁽⁴⁾⁽⁵⁾	28M1	
		ATmega88PA-MU	32M1-A	
		ATmega88PA-MUR ⁽⁵⁾	32M1-A	
		ATmega88PA-PU	28P3	Industrial (-40°C to 105°C)
		ATmega88PA-AN	32A	
		ATmega88PA-ANR ⁽⁵⁾	32A	
		ATmega88PA-MMN ⁽⁴⁾	28M1	
		ATmega88PA-MMNR ⁽⁴⁾⁽⁵⁾	28M1	
		ATmega88PA-MN	32M1-A	
ATmega88PA-MNR ⁽⁵⁾	32M1-A			
ATmega88PA-PN	28P3			

- Note:
1. This device can also be supplied in wafer form. Please contact your local Atmel sales office for detailed ordering information and minimum quantities.
 2. Pb-free packaging complies to the European Directive for Restriction of Hazardous Substances (RoHS directive). Also Halide free and fully Green.
 3. See "Speed Grades" on page 303.
 4. NiPdAu Lead Finish.
 5. Tape & Reel.

	32-lead, Thin (1.0mm) Plastic Quad Flat Package (TQFP)
	32-ball, 4 x 4 x 0.6mm package, ball pitch 0.5 mm, Ultra Thin, Fine-Pitch Ball Grill Array (UFBGA)
	28-pad, 4 x 4 x 1.0 body, Lead Pitch 0.45 mm Quad Flat No-Lead/Micro Lead Frame Package (QFN/MLF)
	32-pad, 5 x 5 x 1.0 body, Lead Pitch 0.50 mm Quad Flat No-Lead/Micro Lead Frame Package (QFN/MLF)
	28-lead, 0.300" Wide, Plastic Dual Inline Package (PDIP)

9.5 ATmega168A

Speed (MHz) ⁽³⁾	Power Supply (V)	Ordering Code ⁽²⁾	Package ⁽¹⁾	Operational Range ⁽⁶⁾
20	1.8 - 5.5	ATmega168A-AU ATmega168A-AUR ⁽⁵⁾ ATmega168A-CCU ATmega168A-CCUR ⁽⁵⁾ ATmega168A-MMH ⁽⁴⁾ ATmega168A-MMHR ⁽⁴⁾⁽⁵⁾ ATmega168A-MU ATmega168A-MUR ⁽⁵⁾ ATmega168A-PU	32A 32A 32CC1 32CC1 28M1 28M1 32M1-A 32M1-A 28P3	Industrial (-40°C to 85°C)

- Note:
1. This device can also be supplied in wafer form. Please contact your local Atmel sales office for detailed ordering information and minimum quantities.
 2. Pb-free packaging complies to the European Directive for Restriction of Hazardous Substances (RoHS directive). Also Halide free and fully Green.
 3. See ["Speed Grades" on page 303](#)
 4. NiPdAu Lead Finish.
 5. Tape & Reel.
 6. Use ["ATmega168PA" on page 21](#), industrial (-40°C to 105°C) as the ATmega48A (-40°C to 105°C) is not presently offered.

	32-lead, Thin (1.0mm) Plastic Quad Flat Package (TQFP)
	32-ball, 4 x 4 x 0.6 mm package, ball pitch 0.5mm, Ultra Thin, Fine-Pitch Ball Grill Array (UFBGA)
	28-pad, 4 x 4 x 1.0 body, Lead Pitch 0.45mm Quad Flat No-Lead/Micro Lead Frame Package (QFN/MLF)
	32-pad, 5 x 5 x 1.0 body, Lead Pitch 0.50mm Quad Flat No-Lead/Micro Lead Frame Package (QFN/MLF)
	28-lead, 0.300" Wide, Plastic Dual Inline Package (PDIP)

9.6 ATmega168PA

Speed (MHz) ⁽³⁾	Power Supply (V)	Ordering Code ⁽²⁾	Package ⁽¹⁾	Operational Range
20	1.8 - 5.5	ATmega168PA-AU ATmega168PA-AUR ⁽⁵⁾ ATmega168PA-CCU ATmega168PA-CCUR ⁽⁵⁾ ATmega168PA-MMH ⁽⁴⁾ ATmega168PA-MMHR ⁽⁴⁾⁽⁵⁾ ATmega168PA-MU ATmega168PA-MUR ⁽⁵⁾ ATmega168PA-PU	32A 32A 32CC1 32CC1 28M1 28M1 32M1-A 32M1-A 28P3	Industrial (-40°C to 85°C)
20	1.8 - 5.5	ATmega168PA-AN ATmega168PA-ANR ⁽⁵⁾ ATmega168PA-MN ATmega168PA-MNR ⁽⁵⁾ ATmega168PA-PN	32A 32A 32M1-A 32M1-A 28P3	Industrial (-40°C to 105°C)

- Note:
1. This device can also be supplied in wafer form. Please contact your local Atmel sales office for detailed ordering information and minimum quantities.
 2. Pb-free packaging complies to the European Directive for Restriction of Hazardous Substances (RoHS directive). Also Halide free and fully Green.
 3. See "[Speed Grades](#)" on page 303.
 4. NiPdAu Lead Finish.
 5. Tape & Reel.

	32-lead, Thin (1.0mm) Plastic Quad Flat Package (TQFP)
	32-ball, 4 x 4 x 0.6mm package, ball pitch 0.5mm, Ultra Thin, Fine-Pitch Ball Grill Array (UFBGA)
	28-pad, 4 x 4 x 1.0 body, Lead Pitch 0.45mm Quad Flat No-Lead/Micro Lead Frame Package (QFN/MLF)
	32-pad, 5 x 5 x 1.0 body, Lead Pitch 0.50mm Quad Flat No-Lead/Micro Lead Frame Package (QFN/MLF)
	28-lead, 0.300" Wide, Plastic Dual Inline Package (PDIP)

9.7 ATmega328

Speed (MHz)	Power Supply (V)	Ordering Code ⁽²⁾	Package ⁽¹⁾	Operational Range ⁽⁶⁾
20 ⁽³⁾	1.8 - 5.5	ATmega328-AU ATmega328-AUR ⁽⁵⁾ ATmega328-MMH ⁽⁴⁾ ATmega328-MMHR ⁽⁴⁾⁽⁵⁾ ATmega328-MU ATmega328-MUR ⁽⁵⁾ ATmega328-PU	32A 32A 28M1 28M1 32M1-A 32M1-A 28P3	Industrial (-40°C to 85°C)

- Note:
1. This device can also be supplied in wafer form. Please contact your local Atmel sales office for detailed ordering information and minimum quantities.
 2. Pb-free packaging complies to the European Directive for Restriction of Hazardous Substances (RoHS directive). Also Halide free and fully Green.
 3. See [Figure 29-1 on page 303](#).
 4. NiPdAu Lead Finish.
 5. Tape & Reel
 6. Use "[ATmega328P](#)" on [page 23](#), industrial (-40°C to 105°C) as the ATmega48A (-40°C to 105°C) is not presently offered.

	32-lead, Thin (1.0mm) Plastic Quad Flat Package (TQFP)
	28-pad, 4 x 4 x 1.0 body, Lead Pitch 0.45mm Quad Flat No-Lead/Micro Lead Frame Package (QFN/MLF)
	28-lead, 0.300" Wide, Plastic Dual Inline Package (PDIP)
	32-pad, 5 x 5 x 1.0 body, Lead Pitch 0.50mm Quad Flat No-Lead/Micro Lead Frame Package (QFN/MLF)

9.8 ATmega328P

Speed (MHz) ⁽³⁾	Power Supply (V)	Ordering Code ⁽²⁾	Package ⁽¹⁾	Operational Range
20	1.8 - 5.5	ATmega328P-AU	32A	Industrial (-40°C to 85°C)
		ATmega328P-AUR ⁽⁵⁾	32A	
ATmega328P-MMH ⁽⁴⁾	28M1			
ATmega328P-MMHR ⁽⁴⁾⁽⁵⁾	28M1			
ATmega328P-MU	32M1-A			
ATmega328P-MUR ⁽⁵⁾	32M1-A			
		ATmega328P-PU	28P3	
		ATmega328P-AN	32A	Industrial (-40°C to 105°C)
		ATmega328P-ANR ⁽⁵⁾	32A	
		ATmega328P-MN	32M1-A	
		ATmega328P-MNR ⁽⁵⁾	32M1-A	
		ATmega328P-PN	28P3	

Note: 1. This device can also be supplied in wafer form. Please contact your local Atmel sales office for detailed ordering information and minimum quantities.

2. Pb-free packaging complies to the European Directive for Restriction of Hazardous Substances (RoHS directive). Also Halide free and fully Green.
3. See [Figure 29-1 on page 303](#).
4. NiPdAu Lead Finish.
5. Tape & Reel.

	32-lead, Thin (1.0mm) Plastic Quad Flat Package (TQFP)
	28-pad, 4 x 4 x 1.0 body, Lead Pitch 0.45mm Quad Flat No-Lead/Micro Lead Frame Package (QFN/MLF)
	28-lead, 0.300" Wide, Plastic Dual Inline Package (PDIP)
	32-pad, 5 x 5 x 1.0 body, Lead Pitch 0.50mm Quad Flat No-Lead/Micro Lead Frame Package (QFN/MLF)

10. Packaging Information

10.1 32A

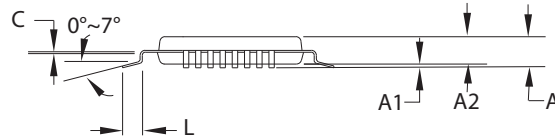
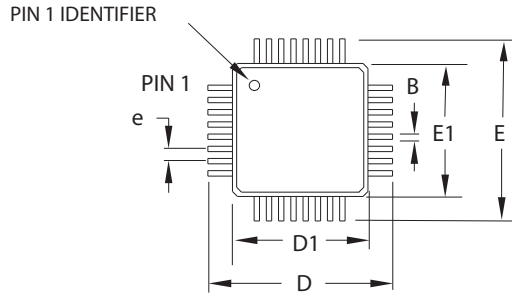

COMMON DIMENSIONS
(Unit of measure = mm)

SYMBOL	MIN	NOM	MAX	NOTE
A	-	-	1.20	
A1	0.05	-	0.15	
A2	0.95	1.00	1.05	
D	8.75	9.00	9.25	
D1	6.90	7.00	7.10	Note 2
E	8.75	9.00	9.25	
E1	6.90	7.00	7.10	Note 2
B	0.30	-	0.45	
C	0.09	-	0.20	
L	0.45	-	0.75	
e	0.80 TYP			

Notes:

1. This package conforms to JEDEC reference MS-026, Variation ABA.
2. Dimensions D1 and E1 do not include mold protrusion. Allowable protrusion is 0.25mm per side. Dimensions D1 and E1 are maximum plastic body size dimensions including mold mismatch.
3. Lead coplanarity is 0.10mm maximum.

2010-10-20

	TITLE	DRAWING NO.	REV.
	32A, 32-lead, 7 x 7mm body size, 1.0mm body thickness, 0.8mm lead pitch, thin profile plastic quad flat package (TQFP)	32A	C

10.2 32CC1

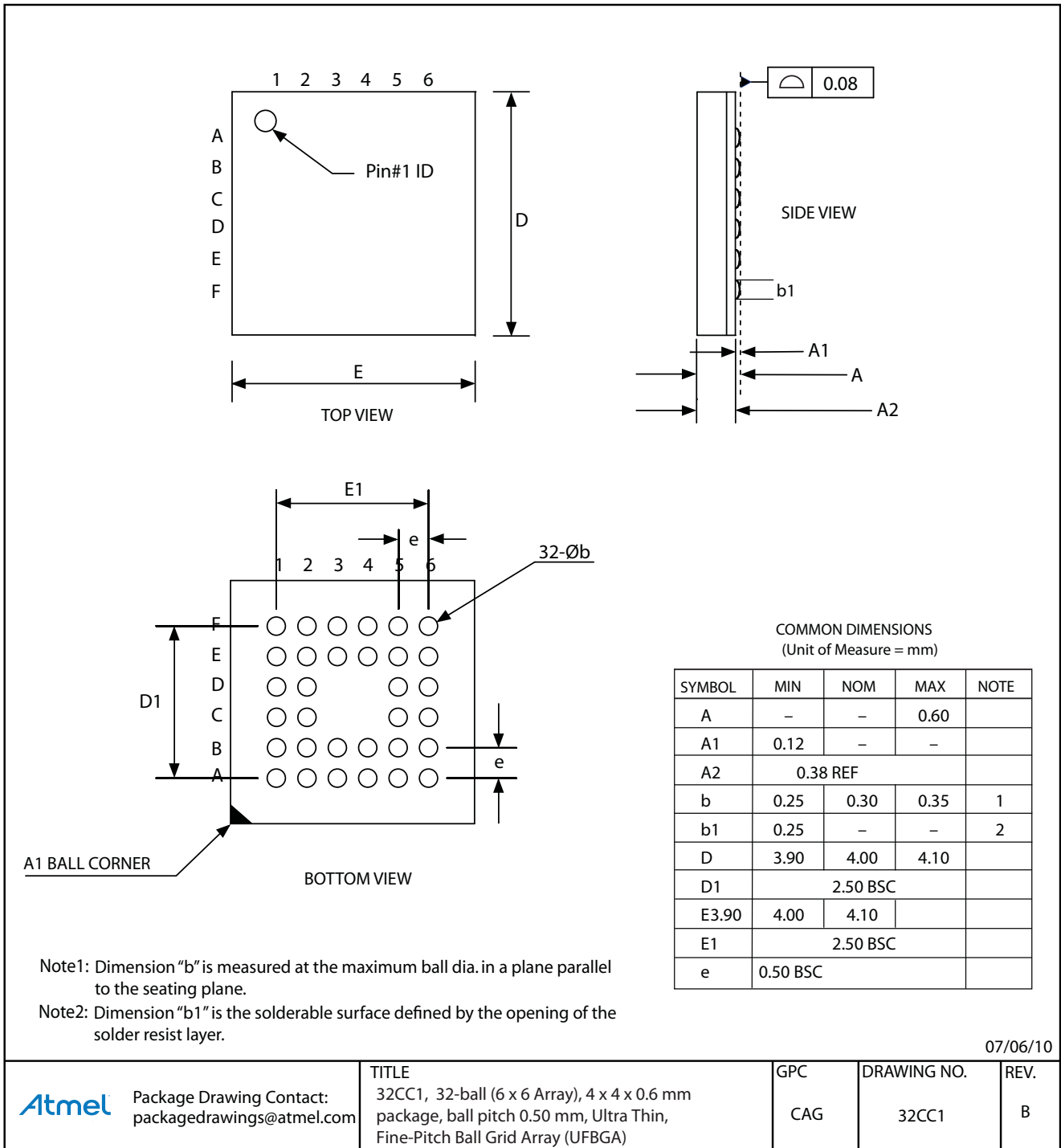

10.3 28M1

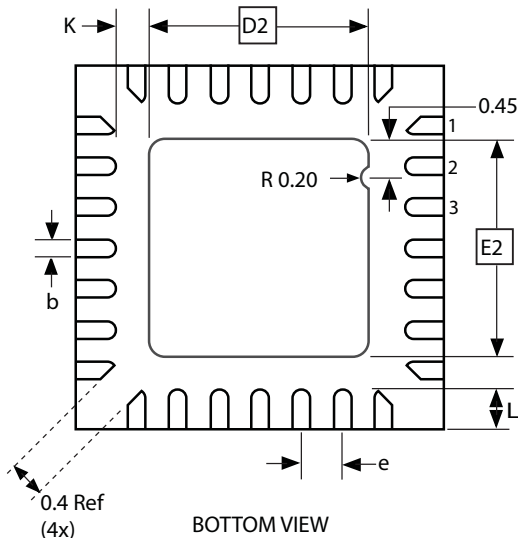
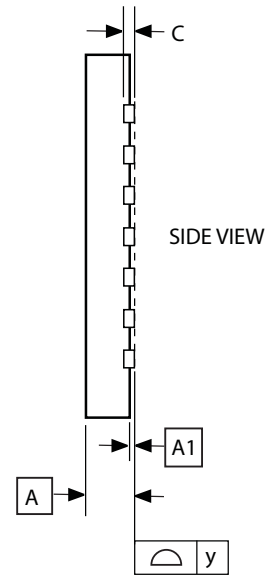
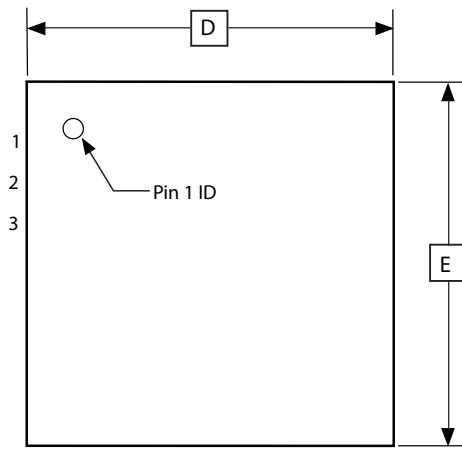

COMMON DIMENSIONS
(Unit of Measure = mm)

SYMBOL	MIN	NOM	MAX	NOTE
A	0.80	0.90	1.00	
A1	0.00	0.02	0.05	
b	0.17	0.22	0.27	
C	0.20 REF			
D	3.95	4.00	4.05	
D2	2.35	2.40	2.45	
E	3.95	4.00	4.05	
E2	2.35	2.40	2.45	
e	0.45			
L	0.35	0.40	0.45	
y	0.00	-	0.08	
K	0.20	-	-	

Note: The terminal #1 ID is a Laser-marked Feature.

10/24/08



Package Drawing Contact:
packagedrawings@atmel.com

TITLE
28M1, 28-pad, 4 x 4 x 1.0mm Body, Lead Pitch 0.45mm,
2.4 x 2.4mm Exposed Pad, Thermally Enhanced
Plastic Very Thin Quad Flat No Lead Package (VQFN)

GPC
ZBV

DRAWING NO.
28M1

REV.
B

10.4 32M1-A

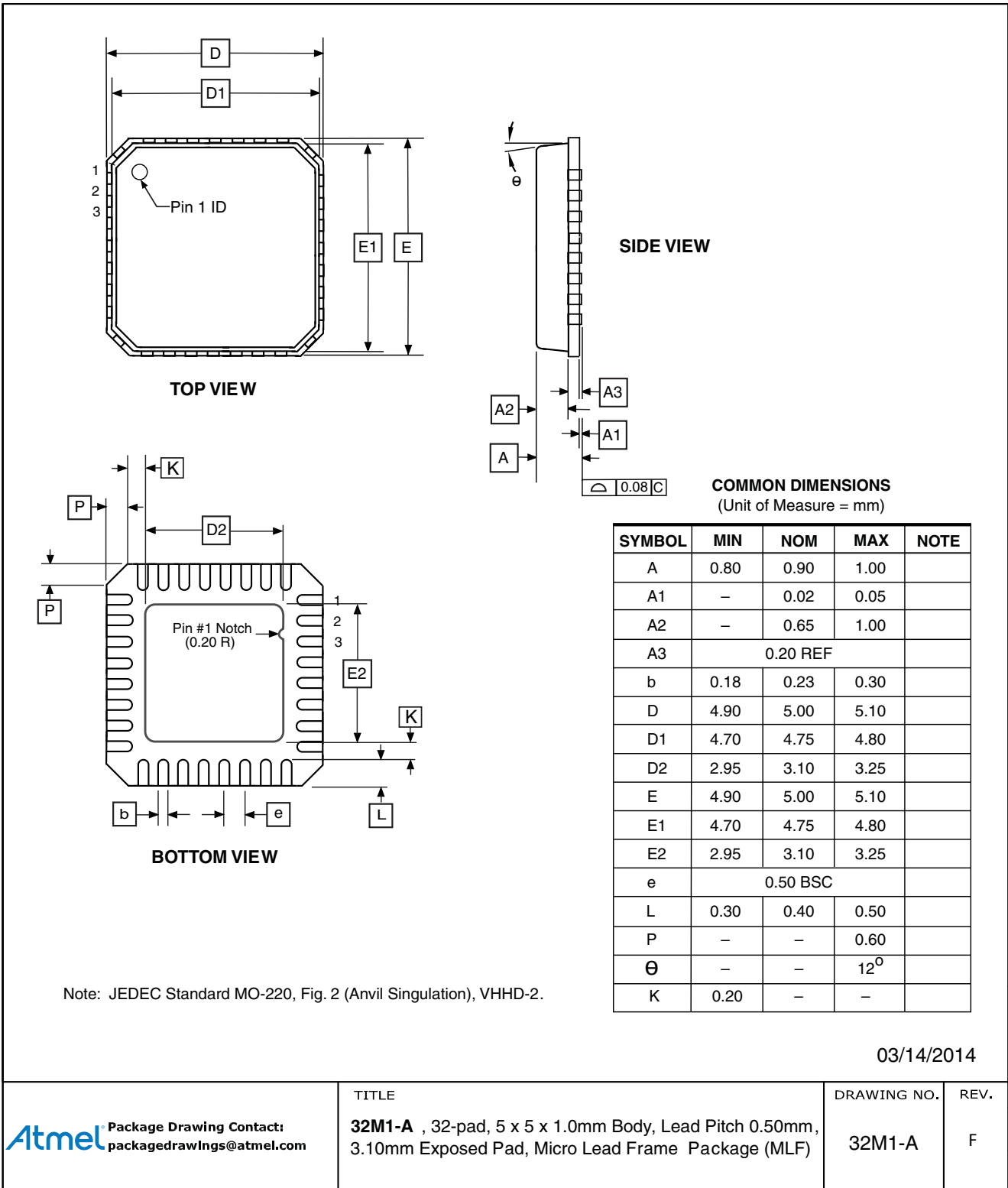

03/14/2014

Atmel Package Drawing Contact:
packagedrawings@atmel.com

TITLE
32M1-A , 32-pad, 5 x 5 x 1.0mm Body, Lead Pitch 0.50mm, 3.10mm Exposed Pad, Micro Lead Frame Package (MLF)

DRAWING NO.
32M1-A

REV.
F

10.5 28P3

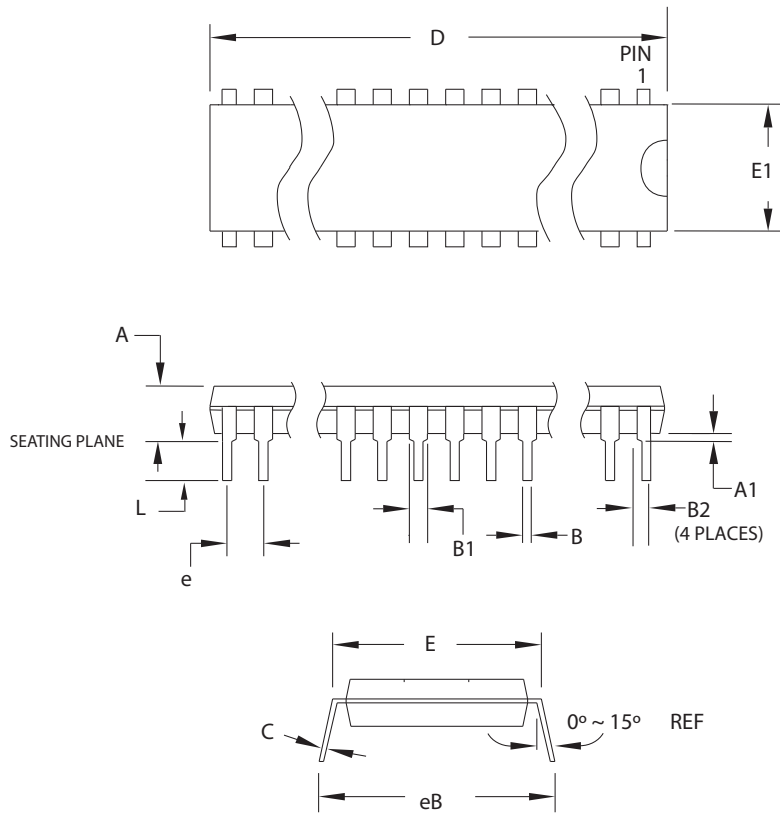

Note: 1. Dimensions D and E1 do not include mold Flash or Protrusion. Mold Flash or Protrusion shall not exceed 0.25mm (0.010").

COMMON DIMENSIONS
(Unit of Measure = mm)

SYMBOL	MIN	NOM	MAX	NOTE
A	-	-	4.5724	
A1	0.508	-	-	
D	34.544	-	34.798	Note 1
E	7.620	-	8.255	
E1	7.112	-	7.493	Note 1
B	0.381	-	0.533	
B1	1.143	-	1.397	
B2	0.762	-	1.143	
L	3.175	-	3.429	
C	0.203	-	0.356	
eB	-	-	10.160	
e	2.540 TYP			

09/28/01

2325 Orchard Parkway San Jose, CA 95131	TITLE	DRAWING NO.	REV.
	28P3, 28-lead (0.300"/7.62mm Wide) Plastic Dual Inline Package (PDIP)	28P3	B

11. Errata

11.1 Errata ATmega48A

The revision letter in this section refers to the revision of the ATmega48A device.

11.1.1 Rev K

- Full swing crystal oscillator not supported
- Parallel programming timing modified
- Write wait delay for NVM is increased
- Changed device ID

1. Full swing crystal oscillator not supported

The full swing crystal oscillator functionality is not available in revision K.

Problem fix/workaround

Use alternative clock sources available in the device.

2. Parallel programming timing modified

Symbol	Parameter	Previous die revision				Revision K			
		Min	Typ.	Max	Units	Min	Typ.	Max	Units
t_{WLRH_CE}	/WR Low to RDY/BSY High for Chip Erase	7.5		9	ms	9.8		10.5	ms
t_{BVDV}	/BS1 Valid to DATA valid	0		250	ns	0		335	ns
t_{OLDV}	/OE Low to DATA Valid			250	ns			335	ns

3 Write wait delay for NVM is increased

The write delay for non-volatile memory (NVM) is increased as follows:

Symbol	Other revisions	Revision K
	Minimum Wait Delay	Minimum Wait Delay
t_{WD_ERASE}	9ms	10.5ms

4. Changed device ID

The device ID has been modified according to the to the following:

Part	Any die revision			Previous die revision	Revision K
	Signature byte address ID (Unchanged)			Device ID read via debugWIRE	Device ID read via debugWIRE
	0x000	0x001	0x002		
ATmega48A	0x1E	0x92	0x05	0x920A	0x920A

11.1.2 Rev. E to J

Not Sampled

11.1.3 Rev. D

- Analog MUX can be turned off when setting ACME bit
- TWI Data setup time can be too short

1. Analog MUX can be turned off when setting ACME bit

If the ACME (Analog Comparator Multiplexer Enabled) bit in ADCSRB is set while MUX3 in ADMUX is '1' (ADMUX[3:0]=1xxx), all MUXes are turned off until the ACME bit is cleared.

Problem Fix/Workaround

Clear the MUX3 bit before setting the ACME bit.

2. TWI Data setup time can be too short

When running the device as a TWI slave with a system clock above 2MHz, the data setup time for the first bit after ACK may in some cases be too short. This may cause a false start or stop condition on the TWI line.

Problem Fix/Workaround

Insert a delay between setting TWDR and TWCR.

11.2 Errata ATmega48PA

The revision letter in this section refers to the revision of the ATmega48PA device.

11.2.1 Rev K

- Full swing crystal oscillator not supported
- Parallel programming timing modified
- Write wait delay for NVM is increased

1. Full swing crystal oscillator not supported

The full swing crystal oscillator functionality is not available in revision K.

Problem fix/workaround

Use alternative clock sources available in the device.

2. Parallel programming timing modified

		Previous die revision				Revision K			
Symbol	Parameter	Min	Typ.	Max	Units	Min	Typ.	Max	Units
t_{WLRH_CE}	/WR Low to RDY/BSY High for Chip Erase	7.5		9	ms	9.8		10.5	ms
t_{BVDV}	/BS1 Valid to DATA valid	0		250	ns	0		335	ns
t_{OLDV}	/OE Low to DATA Valid			250	ns			335	ns

3 Write wait delay for NVM is increased

The write delay for non-volatile memory (NVM) is increased as follows:

	Other revisions	Revision K
Symbol	Minimum Wait Delay	Minimum Wait Delay
t_{WD_ERASE}	9ms	10.5ms

11.2.2 Rev. E to J

Not sampled.

11.2.3 Rev. D

- Analog MUX can be turned off when setting ACME bit
- TWI Data setup time can be too short

1. Analog MUX can be turned off when setting ACME bit

If the ACME (Analog Comparator Multiplexer Enabled) bit in ADCSRB is set while MUX3 in ADMUX is '1' (ADMUX[3:0]=1xxx), all MUXes are turned off until the ACME bit is cleared.

Problem Fix/Workaround

Clear the MUX3 bit before setting the ACME bit.

2. TWI Data setup time can be too short

When running the device as a TWI slave with a system clock above 2MHz, the data setup time for the first bit after ACK may in some cases be too short. This may cause a false start or stop condition on the TWI line.

Problem Fix/Workaround

Insert a delay between setting TWDR and TWCR.

11.2.4 Rev B to C

Not Sampled

11.2.5 Rev. A

- Power consumption in power save modes
- Startup time for the device

1. Power consumption in power save modes

Power consumption in power save modes will be higher due to improper control of internal power management.⁴⁸

Problem Fix/Workaround

This problem will be corrected in Rev B.

2. Startup time for the device

Due to implementation of a different NVM structure, the startup sequence for the device will require longer startup time.

Problem Fix/Workaround

There is no fix for this problem.

11.3 Errata ATmega88A

The revision letter in this section refers to the revision of the ATmega88A device.

11.3.1 Rev K

- Full swing crystal oscillator not supported
- Parallel programming timing modified
- Write wait delay for NVM is increased
- Changed device ID
- Analog MUX can be turned off when setting ACME bit
- TWI Data setup time can be too short

1. Full swing crystal oscillator not supported

The full swing crystal oscillator functionality is not available in revision K.

Problem fix/workaround

Use alternative clock sources available in the device.

2. Parallel programming timing modified

		Previous die revision				Revision K			
Symbol	Parameter	Min	Typ.	Max	Units	Min	Typ.	Max	Units
t_{WLRH_CE}	/WR Low to RDY/BSY High for Chip Erase	7.5		9	ms	9.8		10.5	ms
t_{BVDV}	/BS1 Valid to DATA valid	0		250	ns	0		335	ns
t_{OLDV}	/OE Low to DATA Valid			250	ns			335	ns

3 Write wait delay for NVM is increased

The write delay for non-volatile memory (NVM) is increased as follows:

	Other revisions	Revision K
Symbol	Minimum Wait Delay	Minimum Wait Delay
t_{WD_ERASE}	9ms	10.5ms

4. Changed device ID

The device ID has been modified according to the to the following:

	Any die revision			Previous die revision	Revision K
	Signature byte address ID (Unchanged)			Device ID read via debugWIRE	Device ID read via debugWIRE
Part	0x000	0x001	0x002		
ATmega88A	0x1E	0x93	0x0A	0x930F	0x930F

5. Analog MUX can be turned off when setting ACME bit

If the ACME (Analog Comparator Multiplexer Enabled) bit in ADCSRB is set while MUX3 in ADMUX is '1' (ADMUX[3:0]=1xxx), all MU Xes are turned off until the ACME bit is cleared.

Problem Fix/Workaround

Clear the MUX3 bit before setting the ACME bit.

6. TWI Data setup time can be too short

When running the device as a TWI slave with a system clock above 2MHz, the data setup time for the first bit after ACK may in some cases be too short. This may cause a false start or stop condition on the TWI line.

Problem Fix/Workaround

Insert a delay between setting TWDR and TWCR.

11.3.2 Rev. G to J

Not sampled.

11.3.3 Rev. F

- Analog MUX can be turned off when setting ACME bit
- TWI Data setup time can be too short

1. Analog MUX can be turned off when setting ACME bit

If the ACME (Analog Comparator Multiplexer Enabled) bit in ADCSRB is set while MUX3 in ADMUX is '1' (ADMUX[3:0]=1xxx), all MU Xes are turned off until the ACME bit is cleared.

Problem Fix/Workaround

Clear the MUX3 bit before setting the ACME bit.

2. TWI Data setup time can be too short

When running the device as a TWI slave with a system clock above 2MHz, the data setup time for the first bit after ACK may in some cases be too short. This may cause a false start or stop condition on the TWI line.

Problem Fix/Workaround

Insert a delay between setting TWDR and TWCR.

11.3.4 Rev. A to E

Not Sampled.

11.4 Errata ATmega88PA

The revision letter in this section refers to the revision of the ATmega88PA device.

11.4.1 Rev K

- Full swing crystal oscillator not supported
- Parallel programming timing modified
- Write wait delay for NVM is increased
- Analog MUX can be turned off when setting ACME bit
- TWI Data setup time can be too short

1. Full swing crystal oscillator not supported

The full swing crystal oscillator functionality is not available in revision K.

Problem fix/workaround

Use alternative clock sources available in the device.

2. Parallel programming timing modified

		Previous die revision				Revision K			
Symbol	Parameter	Min	Typ.	Max	Units	Min	Typ.	Max	Units
t_{WLRH_CE}	/WR Low to RDY/BSY High for Chip Erase	7.5		9	ms	9.8		10.5	ms
t_{BVDV}	/BS1 Valid to DATA valid	0		250	ns	0		335	ns
t_{OLDV}	/OE Low to DATA Valid			250	ns			335	ns

3 Write wait delay for NVM is increased

The write delay for non-volatile memory (NVM) is increased as follows:

	Other revisions	Revision K
Symbol	Minimum Wait Delay	Minimum Wait Delay
t_{WD_ERASE}	9ms	10.5ms

4. Analog MUX can be turned off when setting ACME bit

If the ACME (Analog Comparator Multiplexer Enabled) bit in ADCSRB is set while MUX3 in ADMUX is '1' (ADMUX[3:0]=1xxx), all MU Xes are turned off until the ACME bit is cleared.

Problem Fix/Workaround

Clear the MUX3 bit before setting the ACME bit.

5. TWI Data setup time can be too short

When running the device as a TWI slave with a system clock above 2MHz, the data setup time for the first bit after ACK may in some cases be too short. This may cause a false start or stop condition on the TWI line.

Problem Fix/Workaround

Insert a delay between setting TWDR and TWCR.

11.4.2 Rev. G to J

Not sampled

11.4.3 Rev. F

- Analog MUX can be turned off when setting ACME bit
- TWI Data setup time can be too short

1. Analog MUX can be turned off when setting ACME bit

If the ACME (Analog Comparator Multiplexer Enabled) bit in ADCSRB is set while MUX3 in ADMUX is '1' (ADMUX[3:0]=1xxx), all MUXes are turned off until the ACME bit is cleared.

Problem Fix/Workaround

Clear the MUX3 bit before setting the ACME bit.

2. TWI Data setup time can be too short

When running the device as a TWI slave with a system clock above 2MHz, the data setup time for the first bit after ACK may in some cases be too short. This may cause a false start or stop condition on the TWI line.

Problem Fix/Workaround

Insert a delay between setting TWDR and TWCR.

11.4.4 Rev B to E

Not sampled.

11.4.5 Rev. A

- Power consumption in power save modes
- Startup time for the device

1. Power consumption in power save modes

Power consumption in power save modes will be higher due to improper control of internal power management.⁴⁸

Problem Fix/Workaround

This problem will be corrected in Rev B.

2. Startup time for the device

Due to implementation of a different NVM structure, the startup sequence for the device will require longer startup time.

Problem Fix/Workaround

There is no fix for this problem.

11.5 Errata ATmega168A

The revision letter in this section refers to the revision of the ATmega168A device.

11.5.1 Rev K

- Full swing crystal oscillator not supported
- Parallel programming timing modified
- Write wait delay for NVM is increased
- Changed device ID
- Analog MUX can be turned off when setting ACME bit
- TWI Data setup time can be too short

1. Full swing crystal oscillator not supported

The full swing crystal oscillator functionality is not available in revision K.

Problem fix/workaround

Use alternative clock sources available in the device.

2. Parallel programming timing modified

		Previous die revision				Revision K			
Symbol	Parameter	Min	Typ.	Max	Units	Min	Typ.	Max	Units
t_{WLRH_CE}	/WR Low to RDY/BSY High for Chip Erase	7.5		9	ms	9.8		10.5	ms
t_{BVDV}	/BS1 Valid to DATA valid	0		250	ns	0		335	ns
t_{OLDV}	/OE Low to DATA Valid			250	ns			335	ns

3 Write wait delay for NVM is increased

The write delay for non-volatile memory (NVM) is increased as follows:

	Other revisions	Revision K
Symbol	Minimum Wait Delay	Minimum Wait Delay
t_{WD_ERASE}	9ms	10.5ms

4. Changed device ID

The device ID has been modified according to the to the following:

Part	Any die revision			Previous die revision	Revision K
	Signature byte address ID (Unchanged)			Device ID read via debugWIRE	Device ID read via debugWIRE
	0x000	0x001	0x002		
ATmega168A	0x1E	0x94	0x06	0x940B	0x940B

5. Analog MUX can be turned off when setting ACME bit

If the ACME (Analog Comparator Multiplexer Enabled) bit in ADCSRB is set while MUX3 in ADMUX is '1' (ADMUX[3:0]=1xxx), all MUXes are turned off until the ACME bit is cleared.

Problem Fix/Workaround

Clear the MUX3 bit before setting the ACME bit.

6. TWI Data setup time can be too short

When running the device as a TWI slave with a system clock above 2MHz, the data setup time for the first bit after ACK may in some cases be too short. This may cause a false start or stop condition on the TWI line.

Problem Fix/Workaround

Insert a delay between setting TWDR and TWCR.

11.5.2 Rev. F to J

Not sampled.

11.5.3 Rev. E

- Analog MUX can be turned off when setting ACME bit
- TWI Data setup time can be too short

1. Analog MUX can be turned off when setting ACME bit

If the ACME (Analog Comparator Multiplexer Enabled) bit in ADCSRB is set while MUX3 in ADMUX is '1' (ADMUX[3:0]=1xxx), all MUXes are turned off until the ACME bit is cleared.

Problem Fix/Workaround

Clear the MUX3 bit before setting the ACME bit.

2. TWI Data setup time can be too short

When running the device as a TWI slave with a system clock above 2MHz, the data setup time for the first bit after ACK may in some cases be too short. This may cause a false start or stop condition on the TWI line.

Problem Fix/Workaround

Insert a delay between setting TWDR and TWCR.

11.5.4 Rev. A to D

Not sampled.

11.6 Errata ATmega168PA

The revision letter in this section refers to the revision of the ATmega168PA device.

11.6.1 Rev K

- Full swing crystal oscillator not supported
- Parallel programming timing modified
- Write wait delay for NVM is increased
- Analog MUX can be turned off when setting ACME bit
- TWI Data setup time can be too short

1. Full swing crystal oscillator not supported

The full swing crystal oscillator functionality is not available in revision K.

Problem fix/workaround

Use alternative clock sources available in the device.

2. Parallel programming timing modified

		Previous die revision				Revision K			
Symbol	Parameter	Min	Typ.	Max	Units	Min	Typ.	Max	Units
t_{WLRH_CE}	/WR Low to RDY/BSY High for Chip Erase	7.5		9	ms	9.8		10.5	ms
t_{BVDV}	/BS1 Valid to DATA valid	0		250	ns	0		335	ns
t_{OLDV}	/OE Low to DATA Valid			250	ns			335	ns

3 Write wait delay for NVM is increased

The write delay for non-volatile memory (NVM) is increased as follows:

	Other revisions	Revision K
Symbol	Minimum Wait Delay	Minimum Wait Delay
t_{WD_ERASE}	9ms	10.5ms

4. Analog MUX can be turned off when setting ACME bit

If the ACME (Analog Comparator Multiplexer Enabled) bit in ADCSRB is set while MUX3 in ADMUX is '1' (ADMUX[3:0]=1xxx), all MU Xes are turned off until the ACME bit is cleared.

Problem Fix/Workaround

Clear the MUX3 bit before setting the ACME bit.

5. TWI Data setup time can be too short

When running the device as a TWI slave with a system clock above 2MHz, the data setup time for the first bit after ACK may in some cases be too short. This may cause a false start or stop condition on the TWI line.

Problem Fix/Workaround

Insert a delay between setting TWDR and TWCR.

11.6.2 Rev. F to J

Not sampled.

11.6.3 Rev E

- Analog MUX can be turned off when setting ACME bit
- TWI Data setup time can be too short

1. Analog MUX can be turned off when setting ACME bit

If the ACME (Analog Comparator Multiplexer Enabled) bit in ADCSRB is set while MUX3 in ADMUX is '1' (ADMUX[3:0]=1xxx), all MUXes are turned off until the ACME bit is cleared.

Problem Fix/Workaround

Clear the MUX3 bit before setting the ACME bit.

2. TWI Data setup time can be too short

When running the device as a TWI slave with a system clock above 2MHz, the data setup time for the first bit after ACK may in some cases be too short. This may cause a false start or stop condition on the TWI line.

Problem Fix/Workaround

Insert a delay between setting TWDR and TWCR.

11.6.4 Rev A to D

Not sampled.

11.7 Errata ATmega328

The revision letter in this section refers to the revision of the ATmega328 device.

11.7.1 Rev K

- Full swing crystal oscillator not supported
- Parallel programming timing modified
- Write wait delay for NVM is increased
- Changed device ID
- Analog MUX can be turned off when setting ACME bit
- TWI Data setup time can be too short

1. Full swing crystal oscillator not supported

The full swing crystal oscillator functionality is not available in revision K.

Problem fix/workaround

Use alternative clock sources available in the device.

2. Parallel programming timing modified

		Previous die revision				Revision K			
Symbol	Parameter	Min	Typ.	Max	Units	Min	Typ.	Max	Units
t_{WLRH_CE}	/WR Low to RDY/BSY High for Chip Erase	7.5		9	ms	9.8		10.5	ms
t_{BVDV}	/BS1 Valid to DATA valid	0		250	ns	0		335	ns
t_{OLDV}	/OE Low to DATA Valid			250	ns			335	ns

3 Write wait delay for NVM is increased

The write delay for non-volatile memory (NVM) is increased as follows:

	Other revisions	Revision K
Symbol	Minimum Wait Delay	Minimum Wait Delay
t_{WD_ERASE}	9ms	10.5ms

4. Changed device ID

The device ID has been modified according to the to the following:

	Any die revision			Previous die revision	Revision K
	Signature byte address ID (Unchanged)			Device ID read via debugWIRE	Device ID read via debugWIRE
Part	0x000	0x001	0x002		
ATmega328	0x1E	0x95	0x14	0x9514	0x9516

5. Analog MUX can be turned off when setting ACME bit

If the ACME (Analog Comparator Multiplexer Enabled) bit in ADCSRB is set while MUX3 in ADMUX is '1' (ADMUX[3:0]=1xxx), all MUX es are turned off until the ACME bit is cleared.

Problem Fix/Workaround

Clear the MUX3 bit before setting the ACME bit.

6. TWI Data setup time can be too short

When running the device as a TWI slave with a system clock above 2MHz, the data setup time for the first bit after ACK may in some cases be too short. This may cause a false start or stop condition on the TWI line.

Problem Fix/Workaround

Insert a delay between setting TWDR and TWCR.

11.7.2 Rev E to J

Not sampled.

11.7.3 Rev D

- **Analog MUX can be turned off when setting ACME bit**
- **TWI Data setup time can be too short**

1. Analog MUX can be turned off when setting ACME bit

If the ACME (Analog Comparator Multiplexer Enabled) bit in ADCSRB is set while MUX3 in ADMUX is '1' (ADMUX[3:0]=1xxx), all MUXes are turned off until the ACME bit is cleared.

Problem Fix/Workaround

Clear the MUX3 bit before setting the ACME bit.

2. TWI Data setup time can be too short

When running the device as a TWI slave with a system clock above 2MHz, the data setup time for the first bit after ACK may in some cases be too short. This may cause a false start or stop condition on the TWI line.

Problem Fix/Workaround

Insert a delay between setting TWDR and TWCR.

11.7.4 Rev C

Not sampled.

11.7.5 Rev B

- **Analog MUX can be turned off when setting ACME bit**
- **Unstable 32kHz Oscillator**

1. Analog MUX can be turned off when setting ACME bit

If the ACME (Analog Comparator Multiplexer Enabled) bit in ADCSRB is set while MUX3 in ADMUX is '1' (ADMUX[3:0]=1xxx), all MUXes are turned off until the ACME bit is cleared.

Problem Fix/Workaround

Clear the MUX3 bit before setting the ACME bit.

2. Unstable 32kHz Oscillator

The 32kHz oscillator does not work as system clock. The 32kHz oscillator used as asynchronous timer is inaccurate.

Problem Fix/ Workaround

None.

11.7.6 Rev A

- Analog MUX can be turned off when setting ACME bit
- Unstable 32kHz Oscillator

1. Analog MUX can be turned off when setting ACME bit

If the ACME (Analog Comparator Multiplexer Enabled) bit in ADCSRB is set while MUX3 in ADMUX is '1' (ADMUX[3:0]=1xxx), all MUXes are turned off until the ACME bit is cleared.

Problem Fix/Workaround

Clear the MUX3 bit before setting the ACME bit.

2. Unstable 32kHz Oscillator

The 32kHz oscillator does not work as system clock. The 32kHz oscillator used as asynchronous timer is inaccurate.

Problem Fix/ Workaround

None.

11.8 Errata ATmega328P

The revision letter in this section refers to the revision of the ATmega328P device.

11.8.1 Rev K

- Full swing crystal oscillator not supported
- Parallel programming timing modified
- Write wait delay for NVM is increased
- Changed device ID
- Analog MUX can be turned off when setting ACME bit
- TWI Data setup time can be too short

1. Full swing crystal oscillator not supported

The full swing crystal oscillator functionality is not available in revision K.

Problem fix/workaround

Use alternative clock sources available in the device.

2. Parallel programming timing modified

		Previous die revision				Revision K			
Symbol	Parameter	Min	Typ.	Max	Units	Min	Typ.	Max	Units
t_{WLRH_CE}	/WR Low to RDY/BSY High for Chip Erase	7.5		9	ms	9.8		10.5	ms
t_{BVDV}	/BS1 Valid to DATA valid	0		250	ns	0		335	ns
t_{OLDV}	/OE Low to DATA Valid			250	ns			335	ns

3 Write wait delay for NVM is increased

The write delay for non-volatile memory (NVM) is increased as follows:

	Other revisions	Revision K
Symbol	Minimum Wait Delay	Minimum Wait Delay
t_{WD_ERASE}	9ms	10.5ms

4. Changed device ID

The device ID has been modified according to the to the following:

Part	Any die revision			Previous die revision	Revision K
	Signature byte address ID (Unchanged)			Device ID read via debugWIRE	Device ID read via debugWIRE
	0x000	0x001	0x002		
ATmega328P	0x1E	0x95	0x0F	0x950F	0x9516

5. Analog MUX can be turned off when setting ACME bit

If the ACME (Analog Comparator Multiplexer Enabled) bit in ADCSRB is set while MUX3 in ADMUX is '1' (ADMUX[3:0]=1xxx), all MUXes are turned off until the ACME bit is cleared.

Problem Fix/Workaround

Clear the MUX3 bit before setting the ACME bit.

6. TWI Data setup time can be too short

When running the device as a TWI slave with a system clock above 2MHz, the data setup time for the first bit after ACK may in some cases be too short. This may cause a false start or stop condition on the TWI line.

Problem Fix/Workaround

Insert a delay between setting TWDR and TWCR.

11.8.2 Rev E to J

Not sampled.

11.8.3 Rev D

- Analog MUX can be turned off when setting ACME bit
- TWI Data setup time can be too short

1. Analog MUX can be turned off when setting ACME bit

If the ACME (Analog Comparator Multiplexer Enabled) bit in ADCSRB is set while MUX3 in ADMUX is '1' (ADMUX[3:0]=1xxx), all MUXes are turned off until the ACME bit is cleared.

Problem Fix/Workaround

Clear the MUX3 bit before setting the ACME bit.

2. TWI Data setup time can be too short

When running the device as a TWI slave with a system clock above 2MHz, the data setup time for the first bit after ACK may in some cases be too short. This may cause a false start or stop condition on the TWI line.

Problem Fix/Workaround

Insert a delay between setting TWDR and TWCR.

11.8.4 Rev C

Not sampled.

11.8.5 Rev B

- Analog MUX can be turned off when setting ACME bit
- Unstable 32kHz Oscillator

1. Analog MUX can be turned off when setting ACME bit

If the ACME (Analog Comparator Multiplexer Enabled) bit in ADCSRB is set while MUX3 in ADMUX is '1' (ADMUX[3:0]=1xxx), all MUXes are turned off until the ACME bit is cleared.

Problem Fix/Workaround

Clear the MUX3 bit before setting the ACME bit.

2. Unstable 32kHz Oscillator

The 32kHz oscillator does not work as system clock. The 32kHz oscillator used as asynchronous timer is inaccurate.

Problem Fix/ Workaround

None.

11.8.6 Rev A

• **Unstable 32kHz Oscillator**

1. Unstable 32kHz Oscillator

The 32kHz oscillator does not work as system clock. The 32kHz oscillator used as asynchronous timer is inaccurate.

Problem Fix/ Workaround

None.

12. Datasheet Revision History

Please note that the referring page numbers in this section are referred to this document. The referring revision in this section are referring to the document revision.

12.1 Rev. 8271J – 11/2015

1. Updated errata sections:
 - ["Errata ATmega48A" on page 632](#)
 - ["Errata ATmega48PA" on page 633](#)
 - ["Errata ATmega88A" on page 634](#)
 - ["Errata ATmega88PA" on page 636](#)
 - ["Errata ATmega168A" on page 638](#)
 - ["Errata ATmega168PA" on page 640](#)
 - ["Errata ATmega328" on page 642](#)
 - ["Errata ATmega328P" on page 645](#)

12.2 Rev. 8271I – 10/2014

1. Several headings have been corrected and electrical characteristics for 105°C have been structured.

12.3 Rev. 8271H – 08/2014

1. Updated text in section [Section 16.9.3 "Fast PWM Mode" on page 123](#) concerning compare units allowing generation of PWM waveforms (on page 126), referring to table 16-2.
2. Updated WDT Assembly code example in [Section 10.10.5 "Watchdog Timer" on page 43](#) (and onwards)
3. Updated footnote 1 for tables giving DC Characteristics in "" on page 314, ["ATmega88PA DC Characteristics – Current Consumption" on page 315](#), ["ATmega168PA DC Characteristics – Current Consumption" on page 316](#) and ["ATmega328P DC Characteristics – Current Consumption" on page 316](#).
4. [Figure 31-1 on page 318](#) has been updated with the correct plot.
5. [Figure 31-333 on page 493](#) has been updated with the correct plot.
6. Changed description of external interrupt behavior in deep sleep in [Section 13. "External Interrupts" on page 70](#).
7. Added wait delay for t_{WD_FUSE} in [Table 28-18 on page 296](#).
7. Updated errata for rev A of 48PA and 88PA in [Section 11.2 on page 31](#) and [Section 11.4 on page 35](#).
8. Updated back page and footer according to datasheet template of 05/2014

12.4 Rev. 8271G – 02/2013

1. Added ["Electrical Characteristics \(TA = -40°C to 105°C\)" on page 313](#).
2. Added ["ATmega48PA Typical Characteristics – \(TA = -40°C to 105°C\)" on page 517](#).
3. Added ["ATmega88PA Typical Characteristics – \(TA = -40°C to 105°C\)" on page 540](#).
4. Added ["ATmega168PA Typical Characteristics – \(TA = -40°C to 105°C\)" on page 563](#).
5. Added ["ATmega328P Typical Characteristics – \(TA = -40°C to 105°C\)" on page 588](#).

12.5 Rev. 8271F – 08/2012

1. Added ["DC Characteristics" on page 299](#). The following tables for DC characteristics - $T_A = -40^\circ\text{C}$ to 105°C added:
 - [Table 29-2 on page 300](#)
 - [Table 30-3 on page 315](#)
 - [Table 30-4 on page 316](#)
 - [Table 30-5 on page 316](#)
2. Replaced the following typical characteristics by the plots that include les characteristics at " $T_A = -40^\circ\text{C}$ to 105°C ":
 - ["ATmega48PA Typical Characteristics" on page 343](#)

["ATmega88PA Typical Characteristics" on page 392](#)

["ATmega168PA Typical Characteristics" on page 442](#)

["ATmega328P Typical Characteristics" on page 492](#)

3. Removed the Power Save (Psave) maximum numbers for all devices throughout ["Electrical Characteristics – \(TA = -40°C to 85°C\)" on page 299](#).
4. Changed the powerdown maximum numbers from 8.5 and 3µA to 10 and 5µA (ATmega48PA, ATmega88PA, ATmega168PA and ATmega328P).
5. Changed the table note "Maximum values are characterized values and not test limits in production" to "Max values are test limits in production throughout ["Electrical Characteristics – \(TA = -40°C to 85°C\)" on page 299](#).

12.6 Rev. 8271E – 07/2012

1. Updated [Figure 1-1 on page 3](#). Overlined "RESET" in 28 MLF top view and in 32 MLF top view.
2. Added EEAR9 bit to the ["EEARH and EEARL – The EEPROM Address Register" on page 22](#) and updated the all bit descriptions accordingly.
3. Added a footnote "EEAR9 and EEAR8 are unused bits in ATmega48A/48PA and must always be written to zero" to ["EEARH and EEARL – The EEPROM Address Register" on page 22](#).
4. Updated [Table 18-8 on page 155](#), ["Waveform Generation Mode Bit Description"](#). WGM2, WGM1 and WGM0 changed to WGM22, WGM21 and WGM20 respectively.
5. Updated ["TCCR2B – Timer/Counter Control Register B" on page 156](#). bit 2 (CS22) and bit 3 (WGM22) changed from R (read only) to R/W (read/write).
6. Updated the definition of **fosc** on [page 172](#). **fosc** is the system clock frequency (not XTAL pin frequency)
7. Updated ["SPMCSR – Store Program Memory Control and Status Register" on page 261](#). Bit 0 renamed SPMEN and added bit 5 "SIGRD".
8. Replaced "SELFPRGEN" by "SPMEN" throughout the whole datasheet including in the "code examples", except in ["Program And Data Memory Lock Bits" on page 280](#) and in ["Fuse Bits" on page 281](#).
9. Updated ["Register Summary" on page 9](#) to include the bits: SIGRD and SPMEN in the SPMCSR register.
10. Updated the [Table 30-1 on page 313](#). Removed the footnote.
11. Updated the footnote of the [Table 29-13 on page 306](#). Removed the footnote "Note 2".
12. Updated ["Errata" on page 29](#). Added "Errata" TWI Data setup time can be too short.

12.7 Rev. 8271D – 05/11

1. Added Atmel QTouch Sensing Capability Feature
2. Updated ["Register Description" on page 91](#) with PINxn as R/W.
3. Added a footnote to the PINxn, [page 91](#).
4. Updated ["Ordering Information", "ATmega328" on page 22](#). Added "ATmega328-MMH" and "ATmega328-MMHR".
5. Updated ["Ordering Information", "ATmega328P" on page 23](#). Added "ATmega328P-MMH" and "ATmega328P-MMHR".
6. Added ["Ordering Information" for ATmega48PA/88PA/168PA/328P @ 105°C](#)
7. Updated ["Errata ATmega328" on page 41](#) and ["Errata ATmega328P" on page 44](#)
8. Updated the datasheet according to the Atmel new brand style guide.

12.8 Rev. 8271C – 08/10

1. Added 32UFPGA Pinout, [Table 1-1 on page 3](#).
2. Updated the ["SRAM Data Memory", Figure 8-3 on page 19](#).
3. Updated ["Ordering Information" on page 16](#) with CCU and CCUR code related to ["32CC1" Package drawing](#).
4. ["32CC1" Package drawing added "Packaging Information" on page 24](#).

12.9 Rev. 8271B – 04/10

1. Updated [Table 9-8](#) with correct value for timer oscillator at xtal2/tos2
2. Corrected use of SBIS instructions in assembly code examples.
3. Corrected BOD and BODSE bits to R/W in [Section 10.11.2 on page 45](#), [Section 12.5 on page 68](#) and [Section 14.4 on page 91](#)
4. Figures for bandgap characterization added, [Figure 31-34 on page 335](#), [Figure 31-81 on page 360](#), [Figure 31-128 on page 385](#), [Figure 31-176 on page 411](#), [Figure 31-223 on page 435](#), [Figure 31-271 on page 461](#), [Figure 31-318 on page 485](#) and [Figure 31-365 on page 510](#).
5. Updated "[Packaging Information](#)" on [page 24](#) by replacing 28M1 with a correct corresponding package.

12.10 Rev. 8271A – 12/09

1. New datasheet 8271 with merged information for ATmega48PA, ATmega88PA, ATmega168PA and ATmega48A, ATmega88A and ATmega168A. Also included information on ATmega328 and ATmega328P
2. Changes done:
 - New devices added: ATmega48A/ATmega88A/ATmega168A and ATmega328
 - Updated Feature Description
 - Updated [Table 2-1 on page 7](#)
 - Added note for BOD Disable on [page 40](#).
 - Added note on BOD and BODSE in "[MCUCR – MCU Control Register](#)" on [page 91](#) and "[Register Description](#)" on [page 278](#)
 - Added limitation information for the application "[Boot Loader Support – Read-While-Write Self-Programming](#)" on [page 263](#)
 - Added limitation information for "[Program And Data Memory Lock Bits](#)" on [page 280](#)
 - Added specified DC characteristics
 - Added typical characteristics
 - Removed exception information in "[Address Match Unit](#)" on [page 213](#).



Atmel Corporation 1600 Technology Drive, San Jose, CA 95110 USA T: (+1)(408) 441.0311 F: (+1)(408) 436.4200 | www.atmel.com

© 2015 Atmel Corporation. / Rev.: Atmel-8271JS-AVR- ATmega-Datasheet_11/2015.

Atmel®, Atmel logo and combinations thereof, Enabling Unlimited Possibilities, and others are registered trademarks or trademarks of Atmel Corporation in U.S. and other countries. Other terms and product names may be trademarks of others.

DISCLAIMER: The information in this document is provided in connection with Atmel products. No license, express or implied, by estoppel or otherwise, to any intellectual property right is granted by this document or in connection with the sale of Atmel products. EXCEPT AS SET FORTH IN THE ATMEL TERMS AND CONDITIONS OF SALES LOCATED ON THE ATMEL WEBSITE, ATMEL ASSUMES NO LIABILITY WHATSOEVER AND DISCLAIMS ANY EXPRESS, IMPLIED OR STATUTORY WARRANTY RELATING TO ITS PRODUCTS INCLUDING, BUT NOT LIMITED TO, THE IMPLIED WARRANTY OF MERCHANTABILITY, FITNESS FOR A PARTICULAR PURPOSE, OR NON-INFRINGEMENT. IN NO EVENT SHALL ATMEL BE LIABLE FOR ANY DIRECT, INDIRECT, CONSEQUENTIAL, PUNITIVE, SPECIAL OR INCIDENTAL DAMAGES (INCLUDING, WITHOUT LIMITATION, DAMAGES FOR LOSS AND PROFITS, BUSINESS INTERRUPTION, OR LOSS OF INFORMATION) ARISING OUT OF THE USE OR INABILITY TO USE THIS DOCUMENT, EVEN IF ATMEL HAS BEEN ADVISED OF THE POSSIBILITY OF SUCH DAMAGES. Atmel makes no representations or warranties with respect to the accuracy or completeness of the contents of this document and reserves the right to make changes to specifications and products descriptions at any time without notice. Atmel does not make any commitment to update the information contained herein. Unless specifically provided otherwise, Atmel products are not suitable for, and shall not be used in, automotive applications. Atmel products are not intended, authorized, or warranted for use as components in applications intended to support or sustain life.

SAFETY-CRITICAL, MILITARY, AND AUTOMOTIVE APPLICATIONS DISCLAIMER: Atmel products are not designed for and will not be used in connection with any applications where the failure of such products would reasonably be expected to result in significant personal injury or death ("Safety-Critical Applications") without an Atmel officer's specific written consent. Safety-Critical Applications include, without limitation, life support devices and systems, equipment or systems for the operation of nuclear facilities and weapons systems. Atmel products are not designed nor intended for use in military or aerospace applications or environments unless specifically designated by Atmel as military-grade. Atmel products are not designed nor intended for use in automotive applications unless specifically designated by Atmel as automotive-grade.

Mouser Electronics

Authorized Distributor

Click to View Pricing, Inventory, Delivery & Lifecycle Information:

Atmel:

[ATMEGA8-16PI](#) [ATMEGA8-16PC](#) [ATMEGA8-16AI](#) [ATMEGA8-16AC](#) [ATMEGA8L-8AC](#) [ATMEGA8L-8PI](#)
[ATMEGA8L-8MI](#) [ATMEGA8L-8MC](#) [ATMEGA8L-8AI](#) [ATMEGA8L-8PC](#) [ATMEGA168-15AD](#) [ATMEGA168-15MD](#)
[ATMEGA48PA-MU](#) [ATMEGA48PA-AU](#) [ATMEGA48PA-PU](#) [ATMEGA168A-CCUR](#) [ATMEGA168PA-CCUR](#)
[ATMEGA168PA-MMHR](#) [ATMEGA168PA-MUR](#) [ATMEGA328P-AN](#) [ATMEGA328P-ANR](#) [ATMEGA328P-AUR](#)
[ATMEGA328P-MNR](#) [ATMEGA328P-MUR](#) [ATMEGA328P-PN](#) [ATMEGA48A-CCUR](#) [ATMEGA48PA-AUR](#)
[ATMEGA48PA-MMHR](#) [ATMEGA48PA-MUR](#) [ATMEGA88PA-AUR](#) [ATMEGA88PA-MMHR](#) [ATMEGA88PA-MUR](#)
[ATmega8-16MC](#) [ATmega8-16MI](#) [ATMEGA48-15AZV](#) [ATMEGA328P-MU](#) [ATMEGA328P-AU](#) [ATMEGA328P-PU](#)
[ATMEGA8-W](#) [ATMEGA8L-W](#) [ATMEGA88PA-MMH](#) [ATMEGA88PA-PU](#) [ATMEGA88PA-MU](#) [ATMEGA88PA-AU](#)
[ATMEGA48PA-MMH](#) [ATMEGA168PA-MMH](#) [ATmega168PA-PU](#) [ATMEGA168A-AU](#) [ATMEGA168A-AUR](#)
[ATMEGA168A-CCU](#) [ATMEGA168A-MMH](#) [ATMEGA168A-MMHR](#) [ATMEGA168A-MU](#) [ATMEGA168A-MUR](#)
[ATMEGA168A-PU](#) [ATMEGA168PA-CCU](#) [ATMEGA328-AU](#) [ATMEGA328-AUR](#) [ATMEGA328-MU](#) [ATMEGA328-MUR](#)
[ATMEGA328-PU](#) [ATMEGA48A-AU](#) [ATMEGA48A-CCU](#) [ATMEGA48A-MMH](#) [ATMEGA48A-MMHR](#) [ATMEGA48A-MU](#)
[ATMEGA48A-MUR](#) [ATMEGA48A-PU](#) [ATMEGA48PA-CCUR](#) [ATMEGA88A-AU](#) [ATMEGA88A-CCU](#) [ATMEGA88A-CCUR](#)
[ATMEGA88A-MMHR](#) [ATMEGA88A-MU](#) [ATMEGA88A-MUR](#) [ATMEGA88A-PU](#) [ATMEGA88PA-CCU](#)
[ATMEGA88PA-CCUR](#) [ATMEGA168PA-AN](#) [ATMEGA168PA-ANR](#) [ATMEGA168PA-MNR](#) [ATMEGA168PA-PN](#)
[ATMEGA48PA-AN](#) [ATMEGA48PA-ANR](#) [ATMEGA48PA-MMNR](#) [ATMEGA48PA-MN](#) [ATMEGA48PA-MNR](#)
[ATMEGA48PA-PN](#) [ATMEGA88PA-AN](#) [ATMEGA88PA-ANR](#) [ATMEGA88PA-MMN](#) [ATMEGA88PA-MMNR](#)
[ATMEGA88PA-MMUR](#) [ATMEGA88PA-MN](#) [ATMEGA88PA-MNR](#) [ATMEGA88PA-PN](#) [ATMEGA88PA-15MZ](#)
[ATMEGA48PA-15MZ](#) [ATMEGA48PA-15AZ](#) [ATMEGA168PA-15MZ](#)