

**Benutzeranleitung
Kassetten PRO (6 HE)
mit Seitenwand-Eckprofil**

**User Manual
Plug-in units PRO (6 U)
with depth extrusion**

**Instruction utilisateur
Cassettes PRO (6 U)
avec profilé d'angle de flanc**

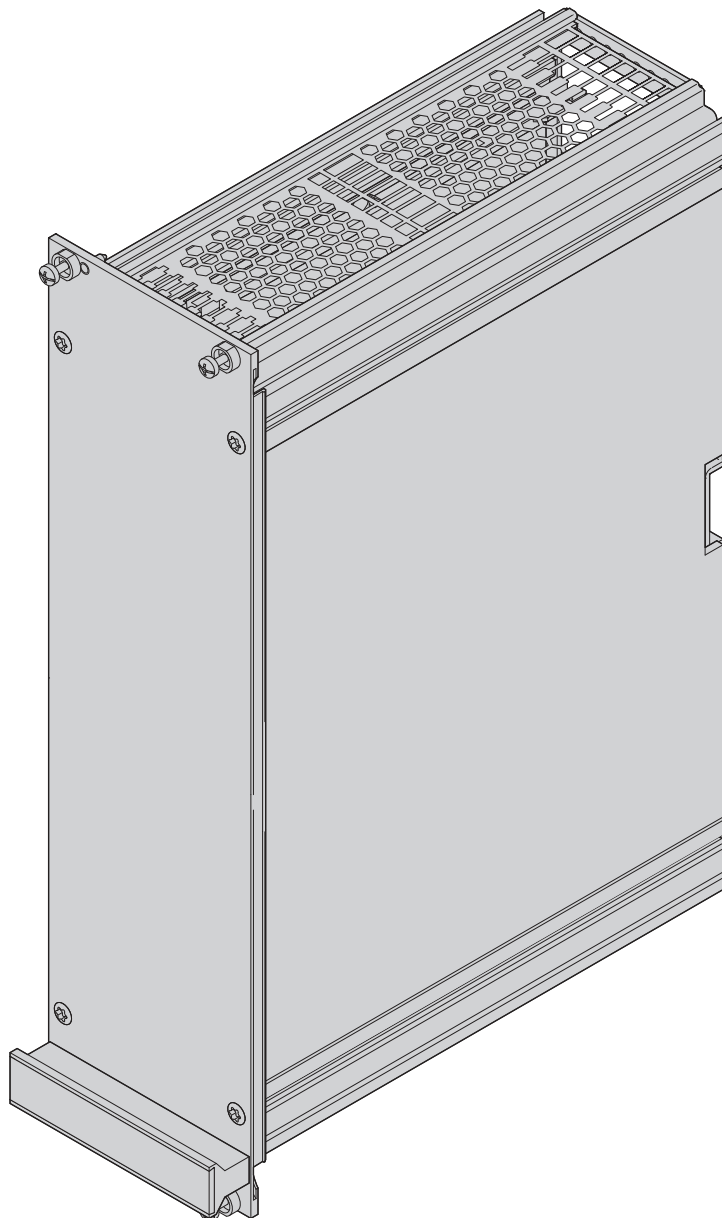

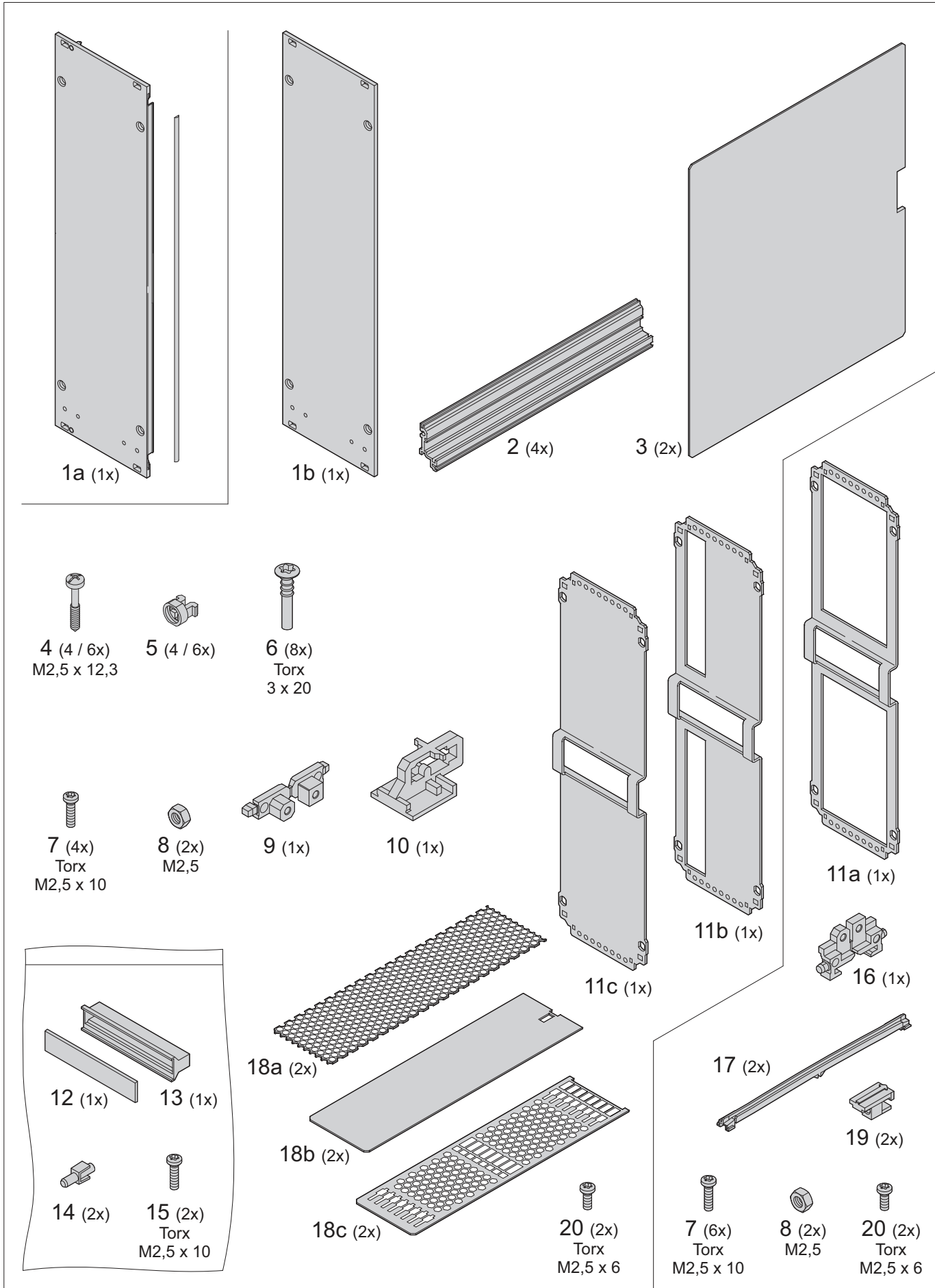

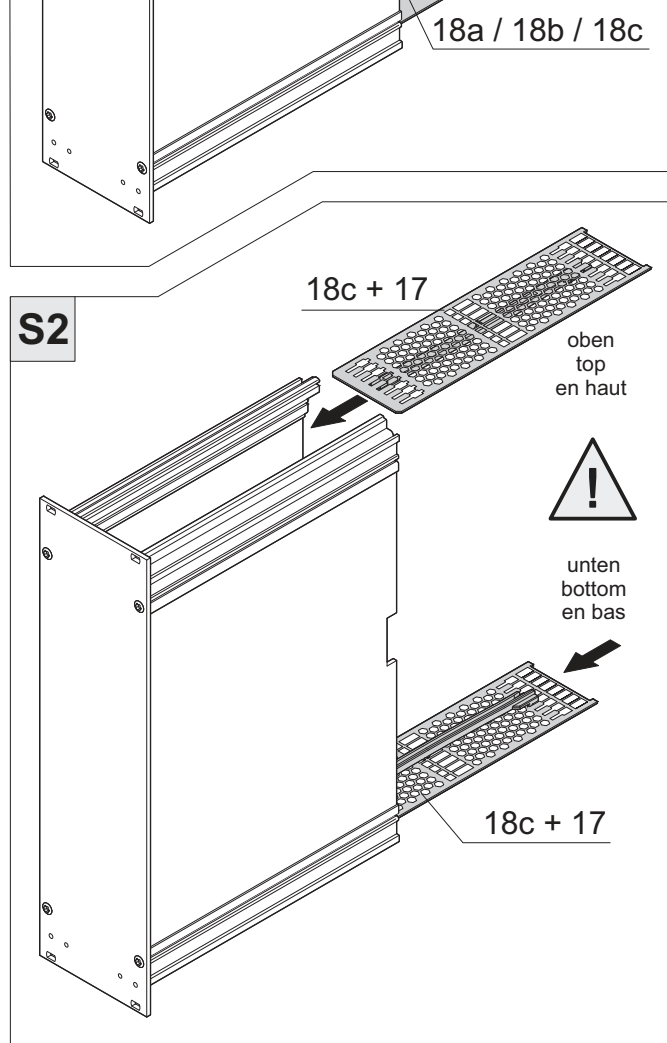
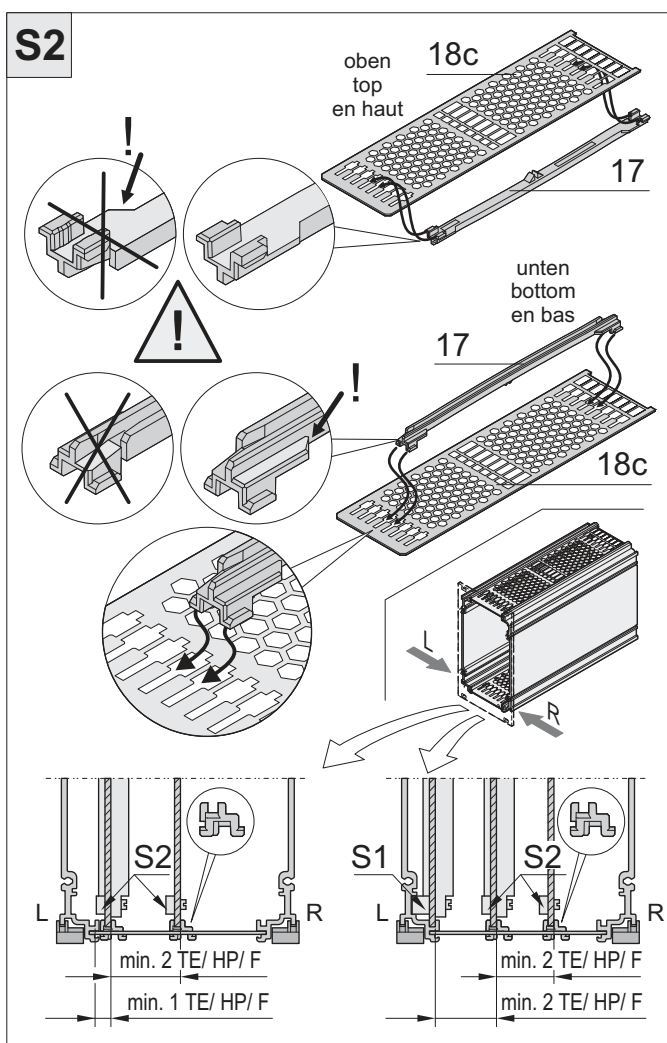
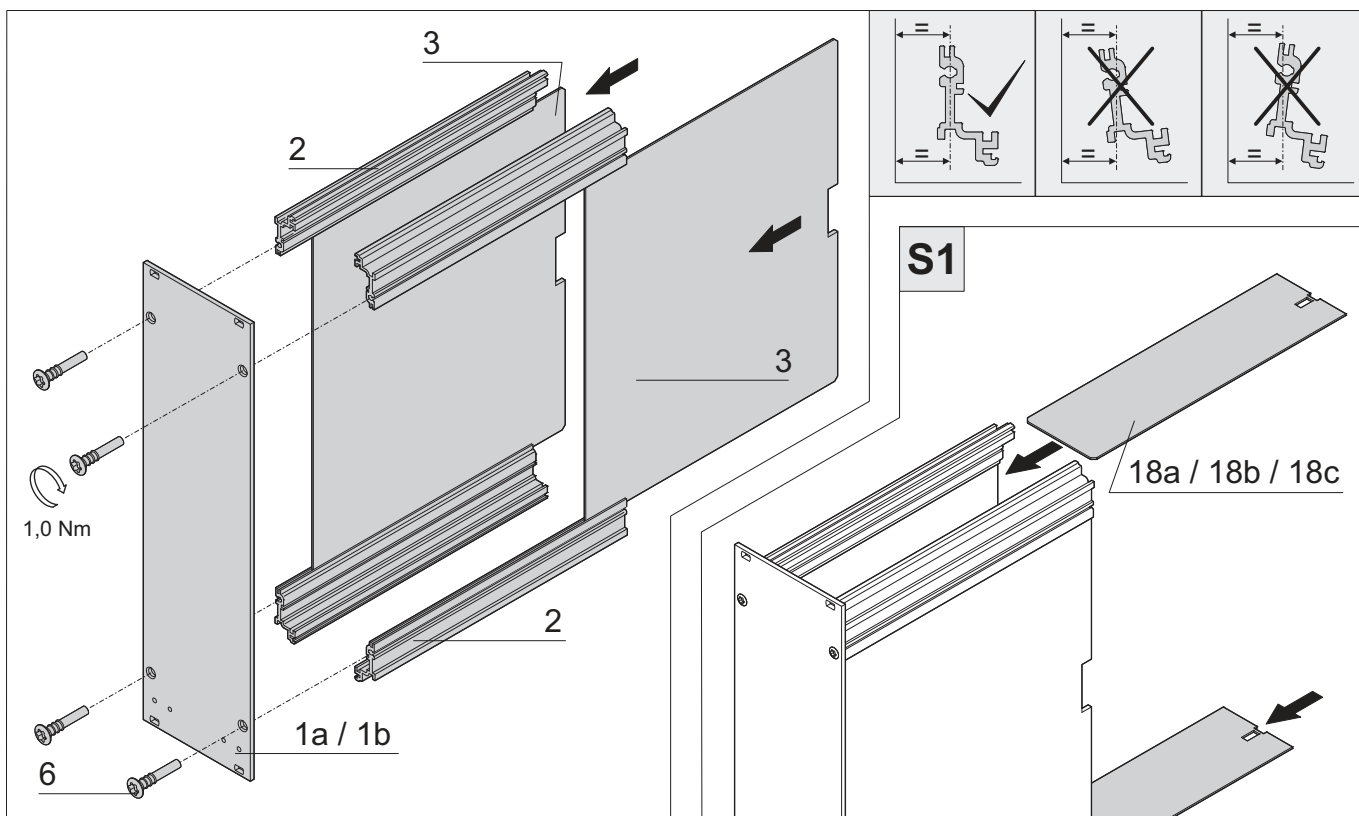

S1 Ohne Steckverbinder
Without connectors
Sans connecteurs

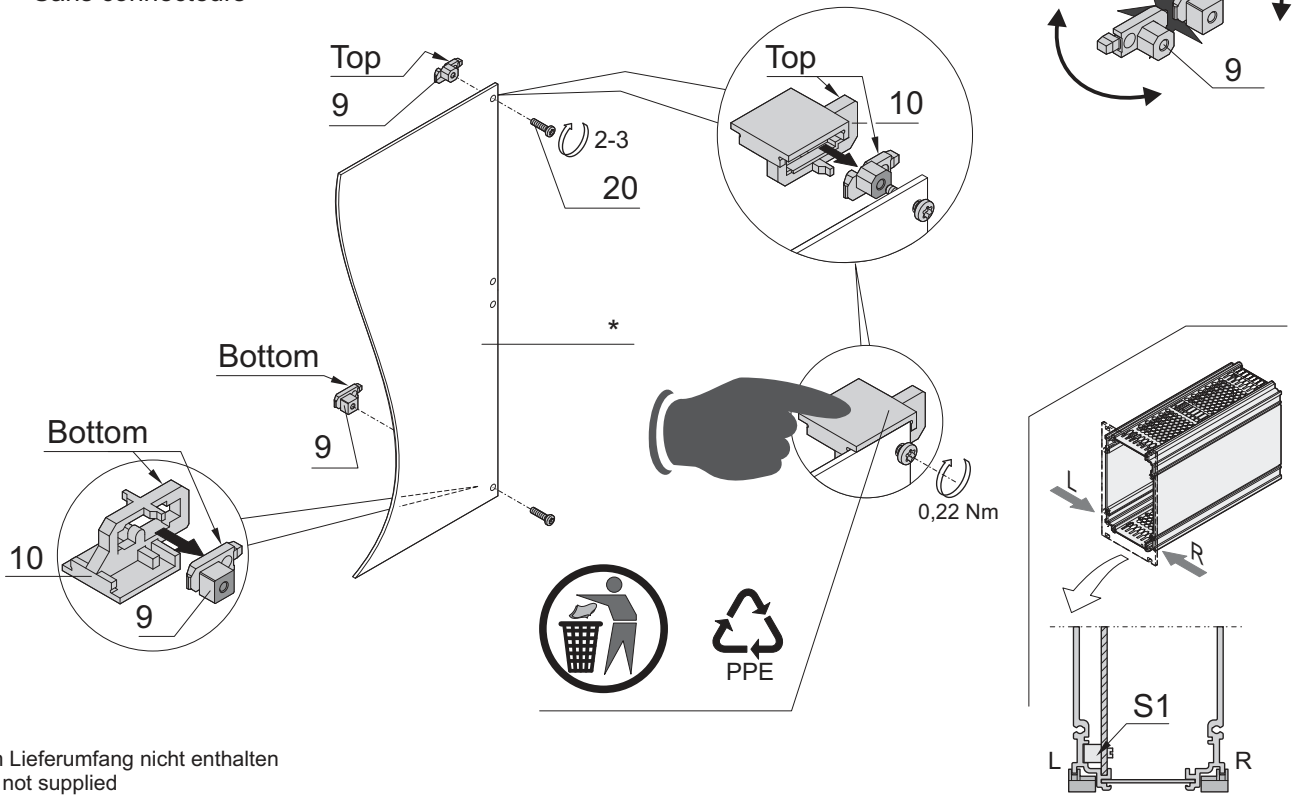

* Im Lieferumfang nicht enthalten
* Is not supplied
* Non compris dans la livraison

S1 Mit Steckverbinder
With connectors
Avec connecteurs

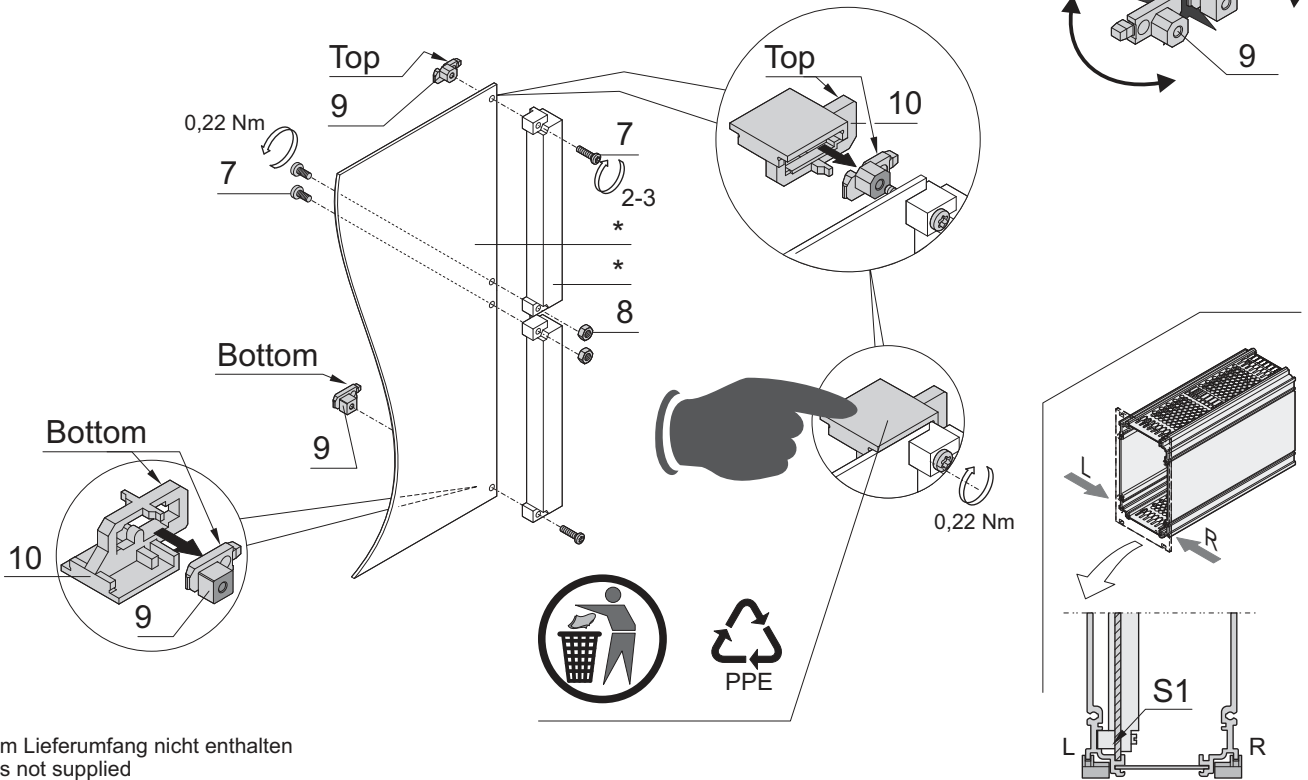

* Im Lieferumfang nicht enthalten
* Is not supplied
* Non compris dans la livraison

S2 Ohne Steckverbinder
Without connectors
Sans connecteurs

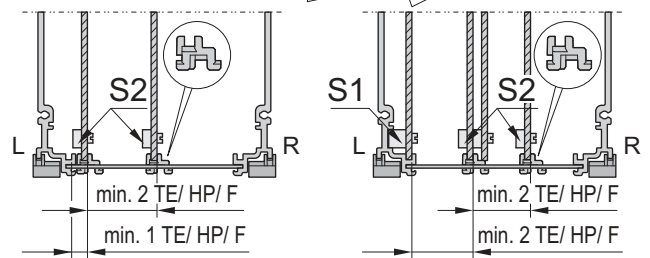
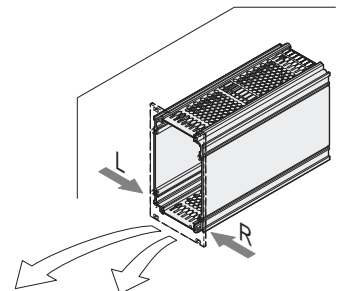
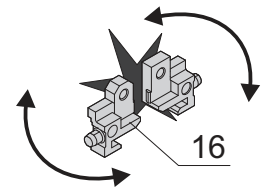
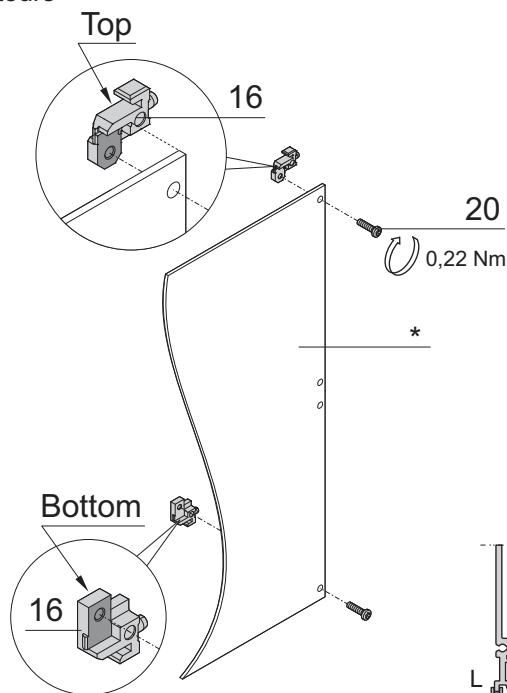

* Im Lieferumfang nicht enthalten
* Is not supplied
* Non compris dans la livraison

S2 Mit Steckverbinder
With connectors
Avec connecteurs

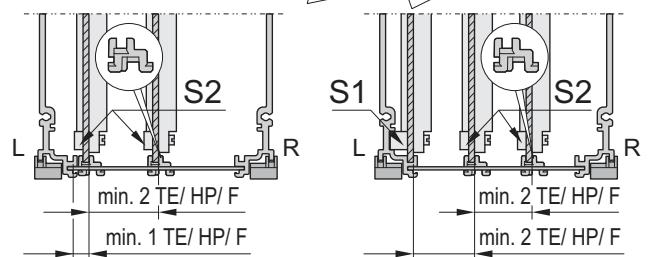
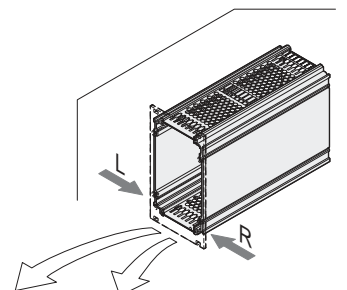
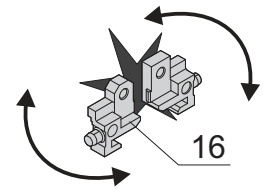
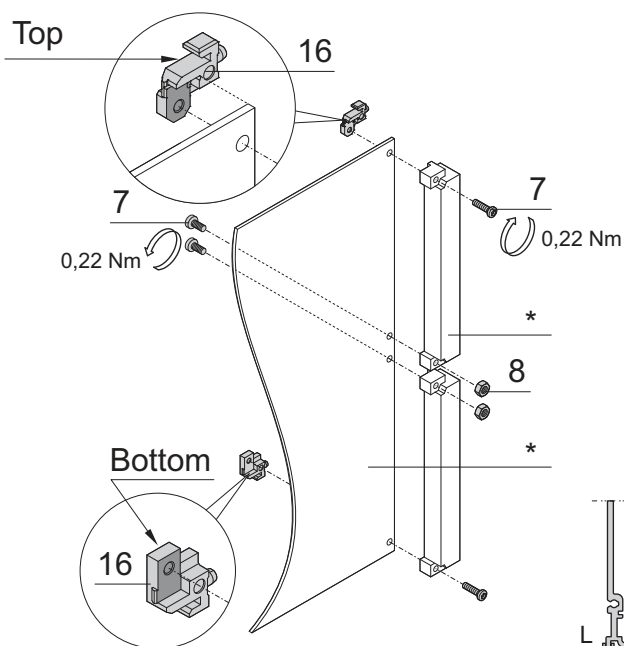

* Im Lieferumfang nicht enthalten
* Is not supplied
* Non compris dans la livraison

S1

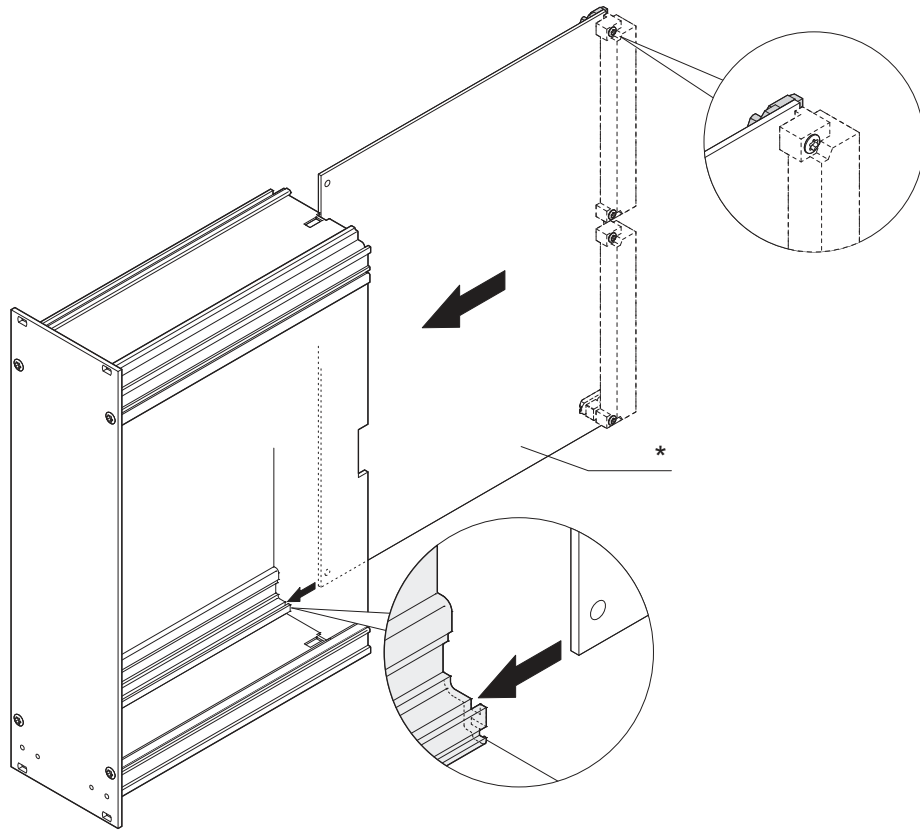

* Im Lieferumfang nicht enthalten * Is not supplied * Non compris dans la livraison

S2

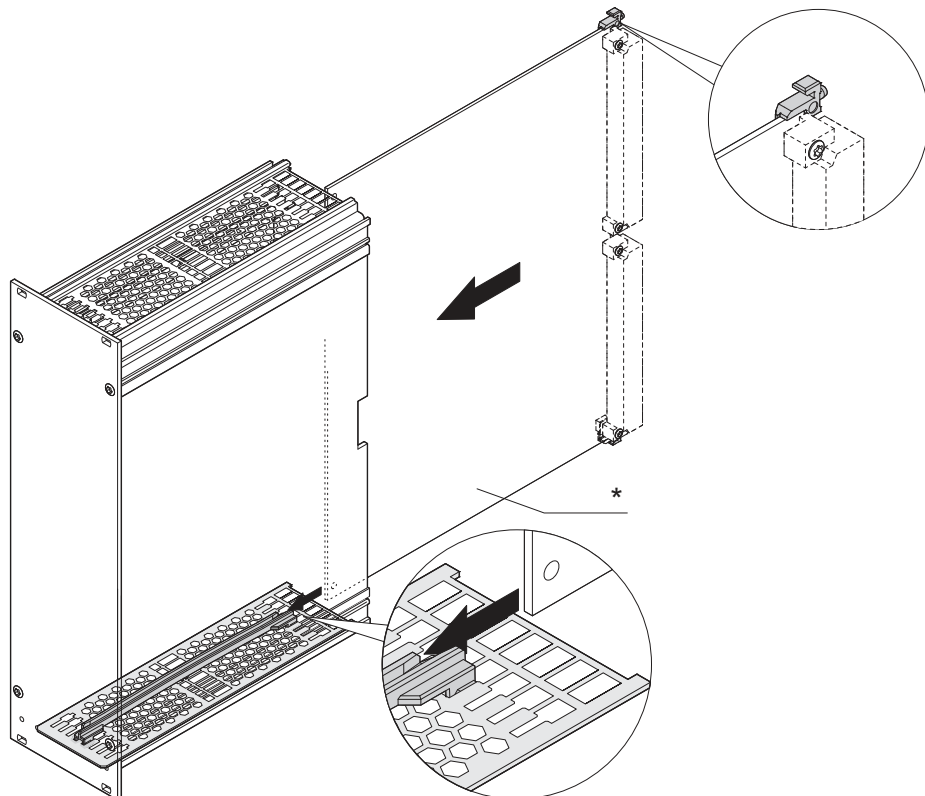

* Im Lieferumfang nicht enthalten * Is not supplied * Non compris dans la livraison

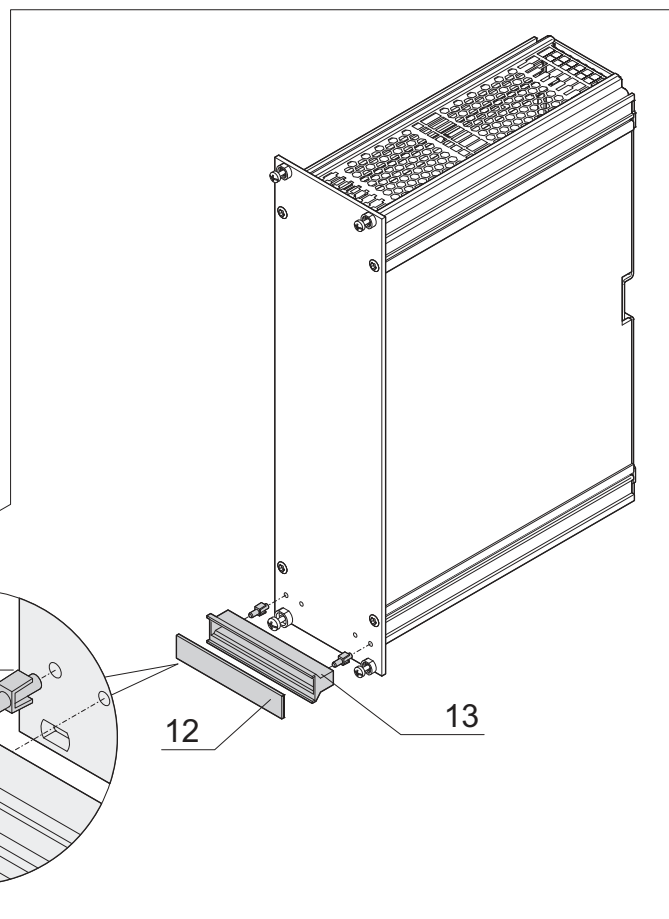
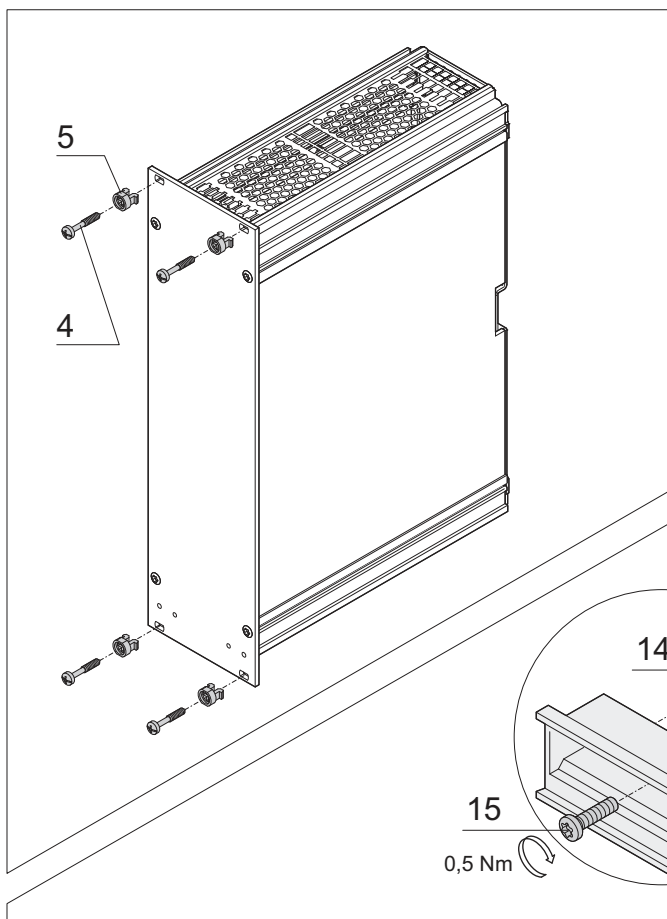
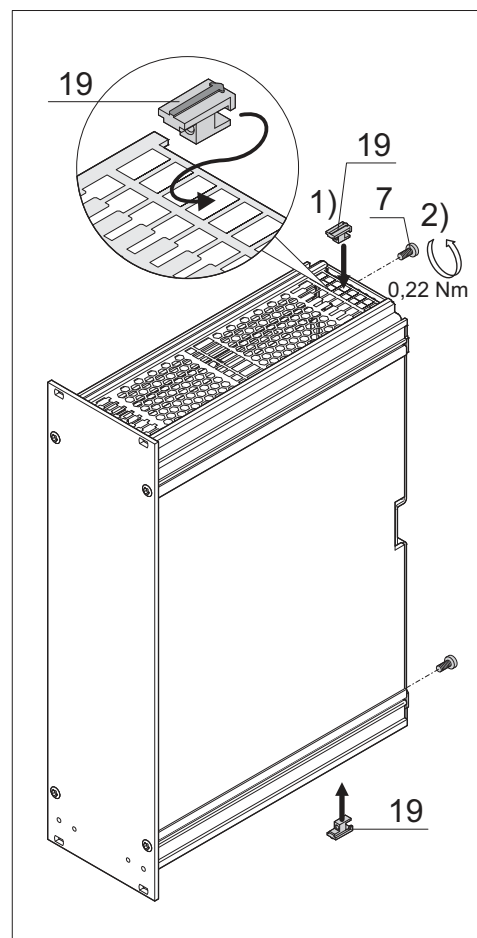
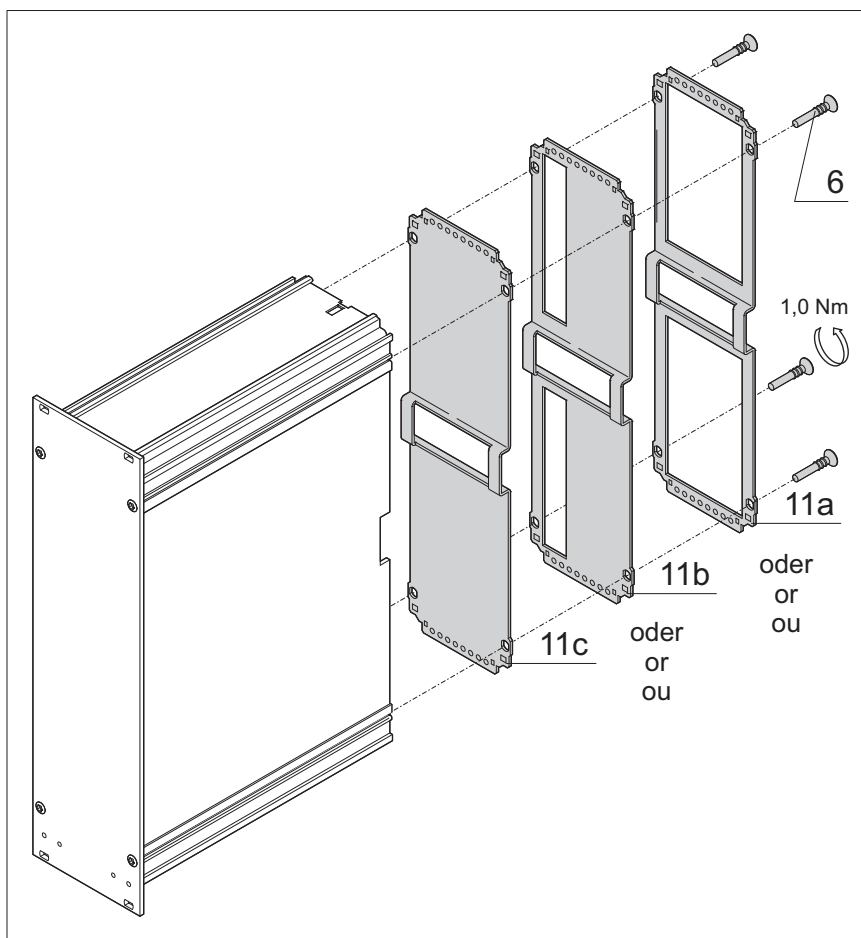

Bitte vor dem Aufkleben der Textildichtung die Metalloberfläche mit Isopropanol reinigen, ablüften lassen und die Klebefläche nicht mehr berühren. Die Dichtung muss nach dem Aufkleben angedrückt werden.

Please clean metal surface with isopropanol prior to applying the fabric gasket. Let dry and do not touch the surface. After affixing the gasket, apply pressure for better adherence.

Nettoyer la surface métallique avec de l'Isopropanol avant de fixer le joint textile. Laisser sécher. Après avoir apposé le joint textile sur la surface, exercer une pression sur le joint.

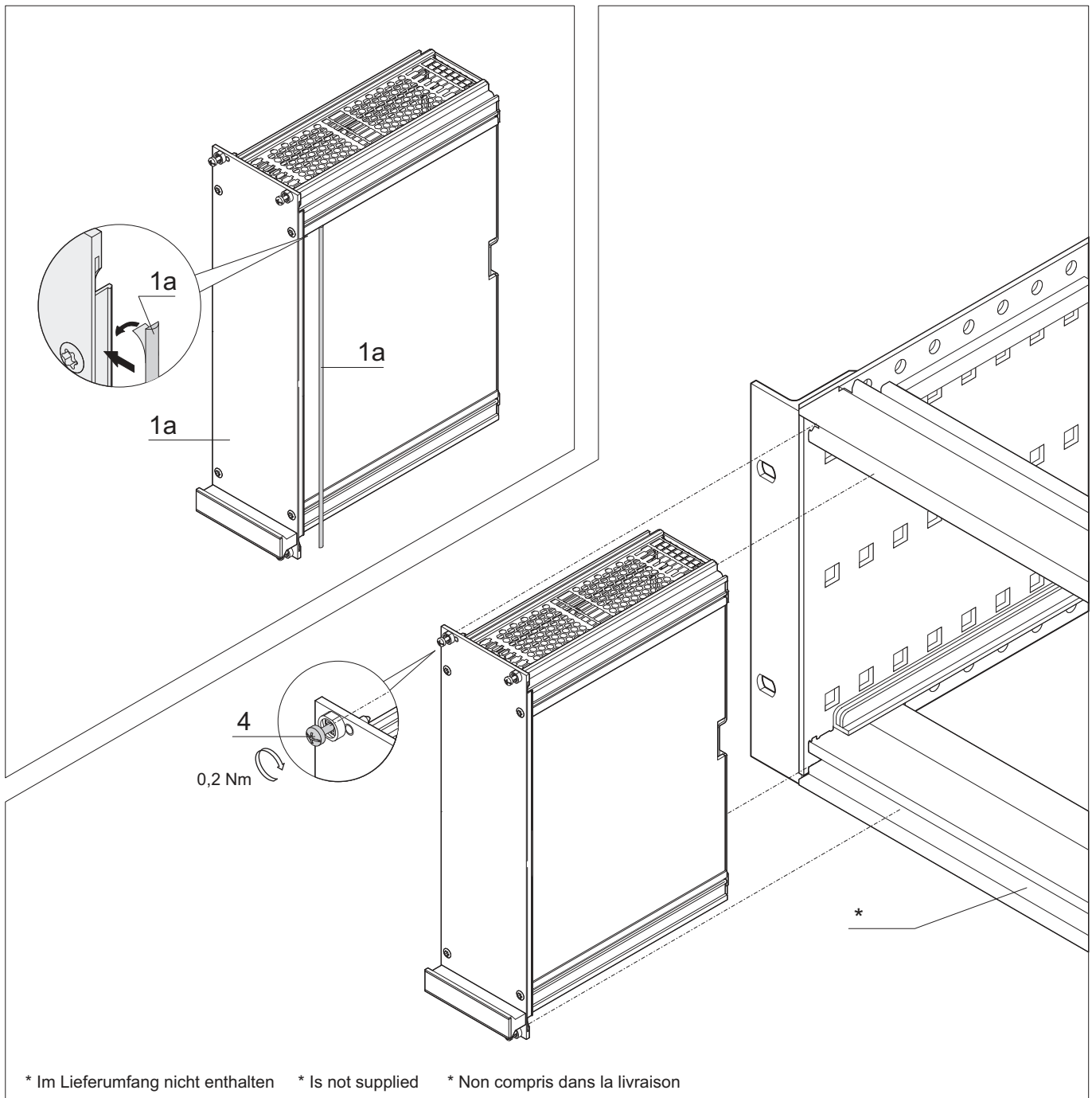
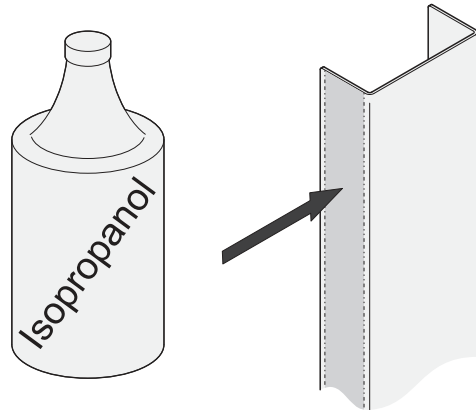

* Im Lieferumfang nicht enthalten * Is not supplied * Non compris dans la livraison