

Small Signal Zener Diodes, Dual

Features

- These diodes are also available in other case styles and configurations including: the dual diode common cathode configuration with type designation DZ23, the single diode SOT23 case with the type designation BZX84C, and the single diode SOD123 case with the type designation BZT52C.
- Dual Silicon Planar Zener Diodes, Common Anode
- The Zener voltages are graded according to the international E 24 standard
- The parameters are valid for both diodes in one case. ΔV_Z and Δr_{zj} of the two diodes in one case is $\leq 5\%$
- Lead (Pb)-free component
- Component in accordance to RoHS 2002/95/EC and WEEE 2002/96/EC

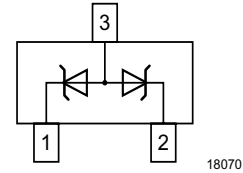
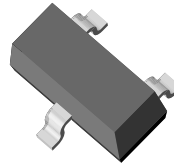

18070

Mechanical Data

Case: SOT23 Plastic case

Weight: approx. 8.8 mg

Packaging Codes/Options:

GS18 / 10 k per 13" reel, (8 mm tape), 10 k/box

GS08 / 3 k per 7" reel, (8 mm tape), 15 k/box

Absolute Maximum Ratings

$T_{amb} = 25\text{ }^\circ\text{C}$, unless otherwise specified

Parameter	Test condition	Symbol	Value	Unit
Power dissipation		P_{tot}	300 ¹⁾	mW

¹⁾ Device on fiberglass substrate, see layout on page 6

Thermal Characteristics

$T_{amb} = 25\text{ }^\circ\text{C}$, unless otherwise specified

Parameter	Test condition	Symbol	Value	Unit
Thermal resistance junction to ambient air		R_{thJA}	420 ¹⁾	K/W
Junction temperature		T_j	150	$^\circ\text{C}$
Storage temperature range		T_{stg}	- 65 to + 150	$^\circ\text{C}$

¹⁾ Device on fiberglass substrate, see layout on page 6

Electrical Characteristics

Partnumber	Marking Code	Zener Voltage Range ¹⁾		Dynamic Resistance		Test Current	Temperature Coefficient of Zener Voltage		Reverse Voltage
		V_Z at I_{ZT}		r_{zj} at $I_{ZT} = 5 \text{ mA}$, $f = 1 \text{ kHz}$	r_{zj} at $I_{ZT} = 1 \text{ mA}$, $f = 1 \text{ kHz}$		I_{ZT}	α_{VZ} at I_{ZT}	
		V		Ω		mA	$10^{-4}/^\circ\text{C}$		V
		min	max				min	max	
AZ23C2V7-V	D1	2.5	2.9	75 (< 83)	< 500	5	- 9	- 4	-
AZ23C3V0-V	D2	2.8	3.2	80 (< 95)	< 500	5	- 9	- 3	-
AZ23C3V3-V	D3	3.1	3.5	80 (< 95)	< 500	5	- 8	- 3	-
AZ23C3V6-V	D4	3.4	3.8	80 (< 95)	< 500	5	- 8	- 3	-
AZ23C3V9-v	D5	3.7	4.1	80 (< 95)	< 500	5	- 7	- 3	-
AZ23C4V3-V	D6	4	4.6	80 (< 95)	< 500	5	- 6	- 1	-
AZ23C4V7-V	D7	4.4	5	70 (< 78)	< 500	5	- 5	2	-
AZ23C5V1-V	D8	4.8	5.4	30 (< 60)	< 480	5	- 3	4	> 0.8
AZ23C5V6-V	D9	5.2	6	10 (< 40)	< 400	5	- 2	6	> 1
AZ23C6V2-V	D10	5.8	6.6	4.8 (< 10)	< 200	5	- 1	7	> 2
AZ23C6V8-V	D11	6.4	7.2	4.5 (< 8)	< 150	5	2	7	> 3
AZ23C7V5-V	D12	7	7.9	4 (< 7)	< 50	5	- 3	7	> 5
AZ23C8V2-V	D13	7.7	8.7	4.5 (< 7)	< 50	5	4	7	> 6
AZ23C9V1-V	D14	8.5	9.6	4.8 (< 10)	< 50	5	5	8	> 7
AZ23C10-V	D15	9.4	10.6	5.2 (< 15)	< 70	5	5	8	> 7.5
AZ23C11-V	D16	10.4	11.6	6 (< 20)	< 70	5	5	9	> 8.5
AZ23C12-V	D17	11.4	12.7	7 (< 20)	< 90	5	6	9	> 9
AZ23C13-V	D18	12.4	14.1	9 (< 25)	< 110	5	7	9	> 10
AZ23C15-V	D19	13.8	15.6	11 (< 30)	< 110	5	7	9	> 11
AZ23C16-V	D20	15.3	17.1	13 (< 40)	< 170	5	8	9.5	> 12
AZ23C18-V	D21	16.8	19.1	18 (< 50)	< 170	5	8	9.5	> 14
AZ23C20-V	D22	18.8	21.2	20 (< 50)	< 220	5	8	10	> 15
AZ23C22-V	D23	20.8	23.3	25 (< 55)	< 220	5	8	10	> 17
AZ23C24-V	D24	22.8	25.6	28 (< 80)	< 220	5	8	10	> 18
AZ23C27-V	D25	25.1	28.9	30 (< 80)	< 250	5	8	10	> 20
AZ23C30-V	D26	28	32	35 (< 80)	< 250	5	8	10	> 22.5
AZ23C33-V	D27	31	35	40 (< 80)	< 250	5	8	10	> 25
AZ23C36-V	D28	34	38	40 (< 90)	< 250	5	8	10	> 27
AZ23C39-V	D29	37	41	50 (< 90)	< 300	5	10	12	> 29
AZ23C43-V	D30	40	46	60 (< 100)	< 700	5	10	12	> 32
AZ23C47-V	D31	44	50	70 (< 100)	< 750	5	10	12	> 35
AZ23C51-V	D32	48	54	70 (< 100)	< 750	5	10	12	> 38

¹⁾ Tested with pulses $t_p = 5 \text{ ms}$



Electrical Characteristics

Partnumber	Marking Code	Zener Voltage Range ¹⁾		Dynamic Resistance		Test Current I_{ZT}	Temperature Coefficient of Zener Voltage		Reverse Voltage V_R at $I_R = 100 \text{ nA}$
		V_Z at I_{ZT}		r_{zj} at $I_{ZT} = 5 \text{ mA}$, $f = 1 \text{ kHz}$	r_{zj} at $I_{ZT} = 1 \text{ mA}$, $f = 1 \text{ kHz}$		α_{VZ} at I_{ZT}		
		V		Ω			$10^{-4}/^{\circ}\text{C}$		
		min	max			mA	min	max	
AZ23B2V7-V	D1	2.65	2.75	75 (< 83)	< 500	5	- 9	- 4	-
AZ23B3V0-V	D2	2.94	3.06	80 (< 95)	< 500	5	- 9	- 3	-
AZ23B3V3-V	D3	3.23	3.37	80 (< 95)	< 500	5	- 8	- 3	-
AZ23B3V6-V	D4	3.53	3.67	80 (< 95)	< 500	5	- 8	- 3	-
AZ23B3V9-V	D5	3.82	3.98	80 (< 95)	< 500	5	- 7	- 3	-
AZ23B4V3-V	D6	4.21	4.39	80 (< 95)	< 500	5	- 6	- 1	-
AZ23B4V7-V	D7	4.61	4.79	70 (< 78)	< 500	5	- 5	2	-
AZ23B5V1-V	D8	5	5.2	30 (< 60)	< 480	5	- 3	4	> 0.8
AZ23B5V6-V	D9	5.49	5.71	10 (< 40)	< 400	5	- 2	6	> 1
AZ23B6V2-V	D10	6.08	6.32	4.8 (< 10)	< 200	5	- 1	7	> 2
AZ23B6V8-V	D11	6.66	6.94	4.5 (< 8)	< 150	5	2	7	> 3
AZ23B7V5-V	D12	7.35	7.65	4 (< 7)	< 50	5	- 3	7	> 5
AZ23B8V2-V	D13	8.04	8.36	4.5 (< 7)	< 50	5	4	7	> 6
AZ23B9V1-V	D14	8.92	9.28	4.8 (< 10)	< 50	5	5	8	> 7
AZ23B10-V	D15	9.8	10.2	5.2 (< 15)	< 70	5	5	8	> 7.5
AZ23B11-V	D16	10.8	11.2	6 (< 20)	< 70	5	5	9	> 8.5
AZ23B12-V	D17	11.8	12.2	7 (< 20)	< 90	5	6	9	> 9
AZ23B13-V	D18	12.7	13.3	9 (< 25)	< 110	5	7	9	> 10
AZ23B15-V	D19	14.7	15.3	11 (< 30)	< 110	5	7	9	> 11
AZ23B16-V	D20	15.7	16.3	13 (< 40)	< 170	5	8	0.5	> 12
AZ23B18-V	D21	17.6	18.4	18 (< 50)	< 170	5	8	0.5	> 14
AZ23B20-V	D22	19.6	20.4	20 (< 50)	< 220	5	8	10	> 15
AZ23B22-V	D23	21.6	22.4	25 (< 55)	< 220	5	8	10	> 17
AZ23B24-V	D24	23.5	24.5	28 (< 80)	< 220	5	8	10	> 18
AZ23B27-V	D25	26.5	27.5	30 (< 80)	< 250	5	8	10	> 20
AZ23B30-V	D26	29.4	30.6	35 (< 80)	< 250	5	8	10	> 22.5
AZ23B33-V	D27	32.3	33.7	40 (< 80)	< 250	5	8	10	> 25
AZ23B36-V	D28	35.3	36.7	40 (< 90)	< 250	5	8	10	> 27
AZ23B39-V	D29	38.2	39.8	50 (< 90)	< 300	5	10	12	> 29
AZ23B43-V	D30	42.1	43.9	60 (< 100)	< 700	5	10	12	> 32
AZ23B47-V	D31	46.1	47.9	70 (< 100)	< 750	5	10	12	> 35
AZ23B51-V	D32	50	52	70 (< 100)	< 750	5	10	12	> 38

¹⁾ Tested with pulses $t_p = 5 \text{ ms}$

Typical Characteristics

$T_{amb} = 25\text{ }^{\circ}\text{C}$, unless otherwise specified

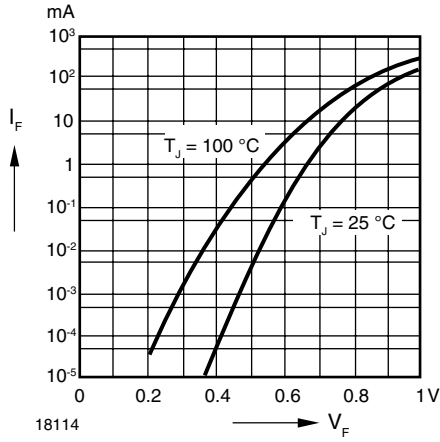

Figure 1. Forward characteristics

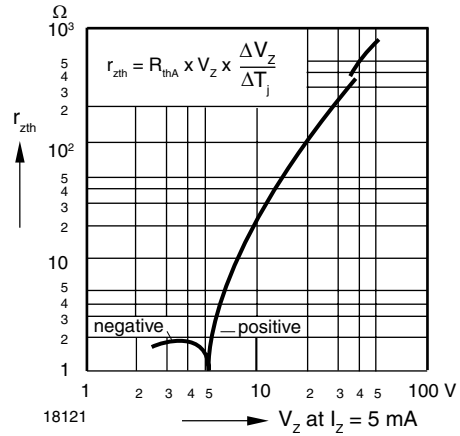

Figure 4. Thermal Differential Resistance vs. Zener Voltage

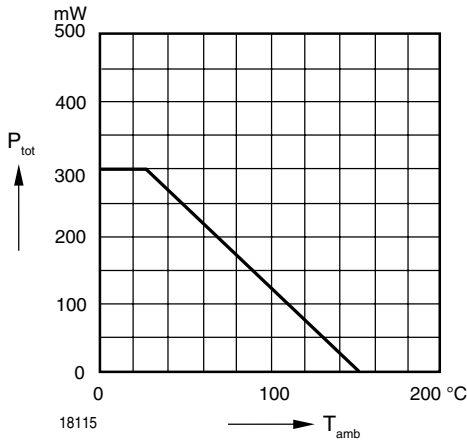

Figure 2. Admissible Power Dissipation vs. Ambient Temperature

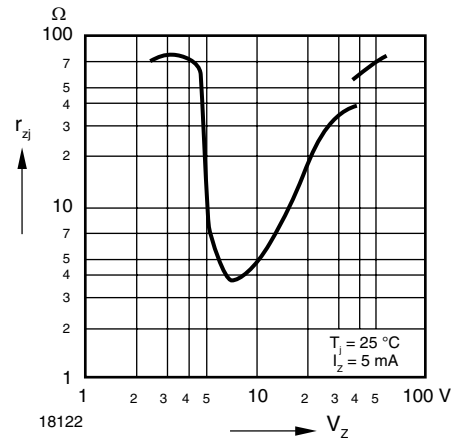

Figure 5. Dynamic Resistance vs. Zener Voltage

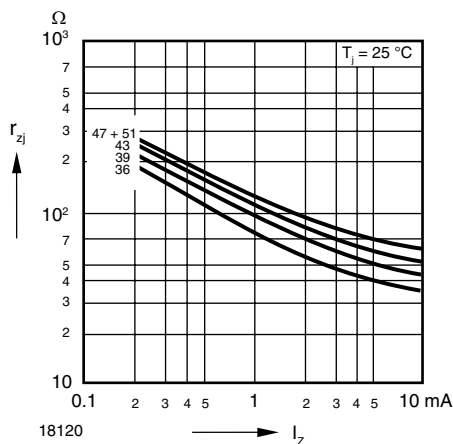

Figure 3. Dynamic Resistance vs. Zener Current

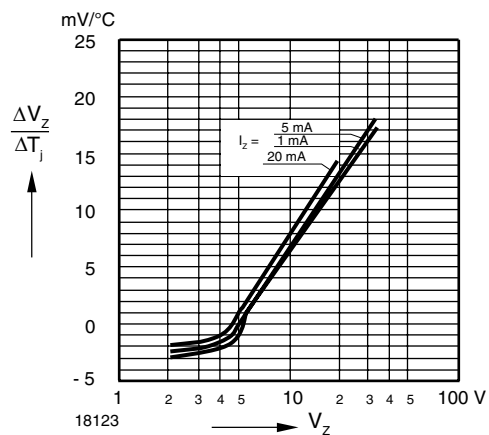

Figure 6. Temperature Dependence of Zener Voltage vs. Zener Voltage

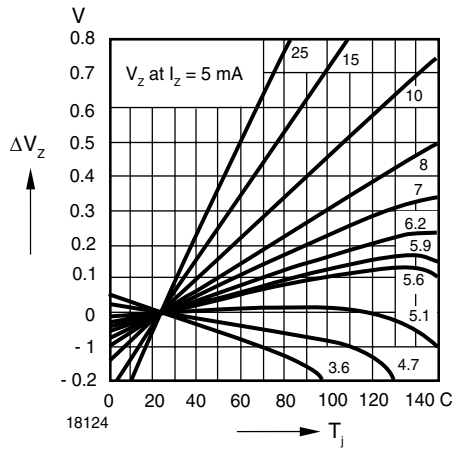

Figure 7. Change of Zener Voltage vs. Junction Temperature

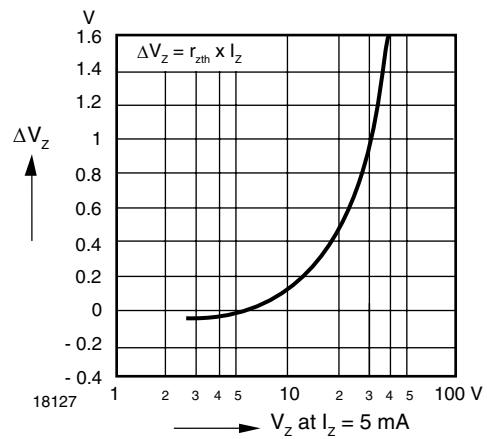

Figure 10. Change of Zener voltage from turn-on up to the point of thermal equilibrium vs. Zener voltage

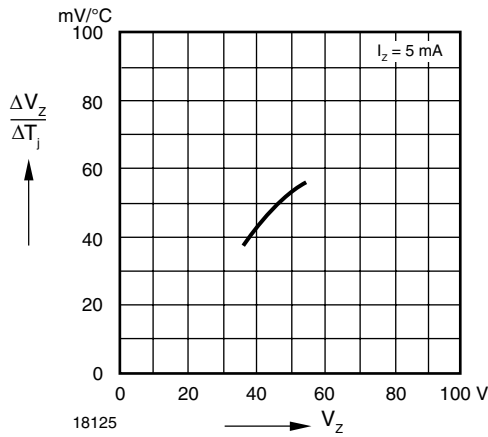

Figure 8. Temperature Dependence of Zener Voltage vs. Zener Voltage

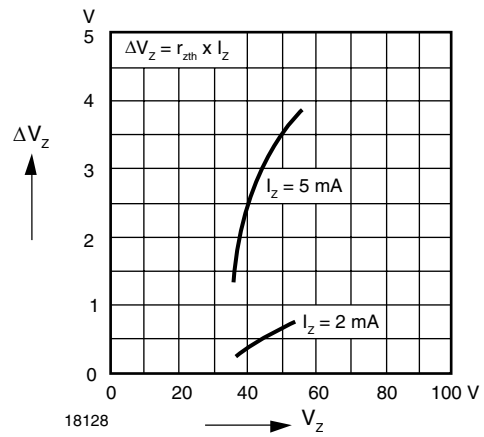

Figure 11. Change of Zener voltage from turn-on up to the point of thermal equilibrium vs. Zener voltage

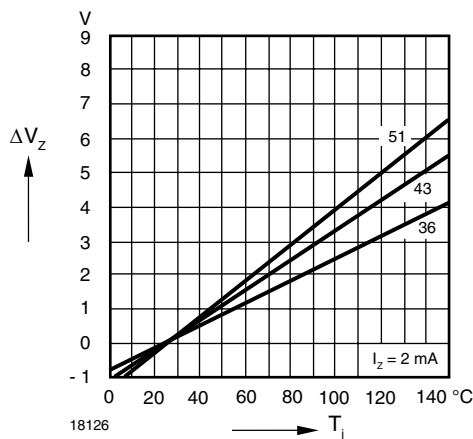

Figure 9. Change of Zener Voltage vs. Junction Temperature

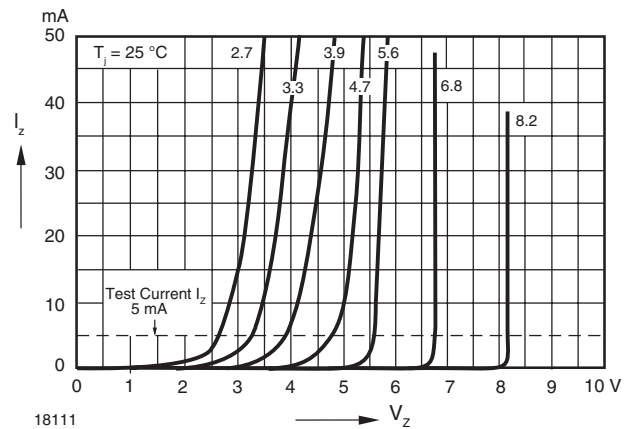

Figure 12. Breakdown Characteristics

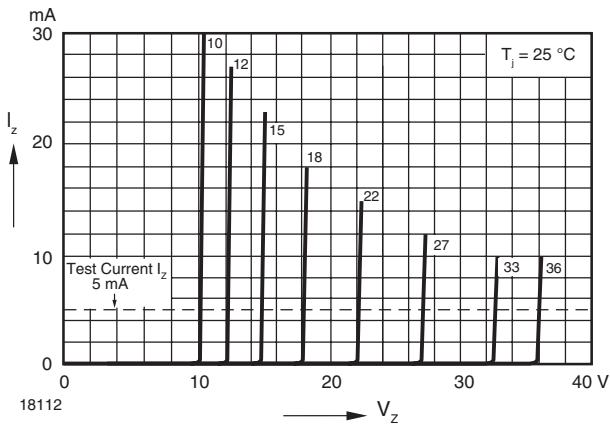

Figure 13. Breakdown Characteristics

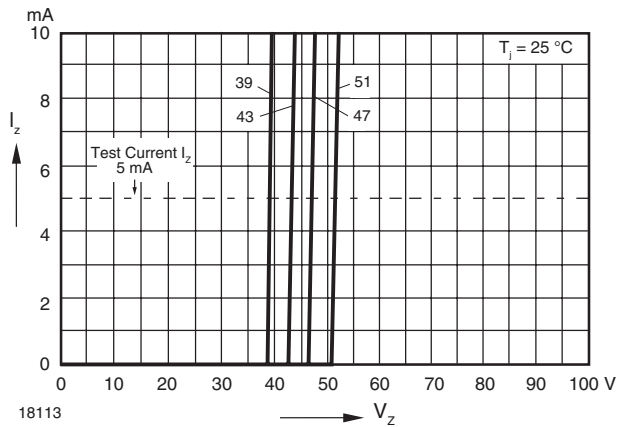
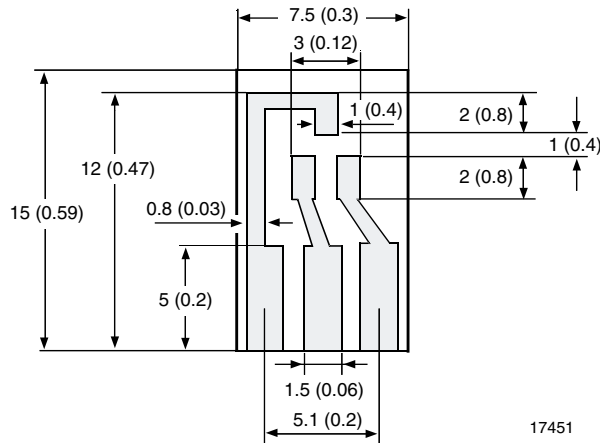

Figure 14. Breakdown Characteristics

Layout for R_{thJA} test

Thickness: Fiberglass 0.059 in. (1.5 mm)

Copper leads 0.012 in. (0.3 mm)



Package Dimensions in mm (Inches)

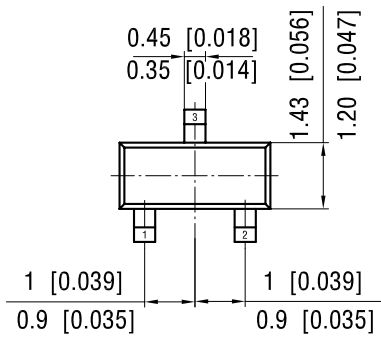
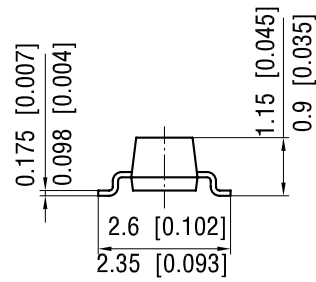
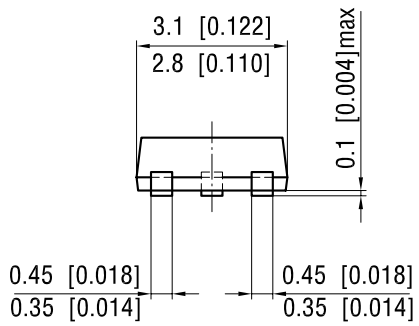

foot print recommendation:

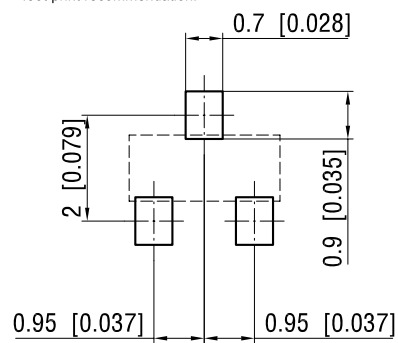

Document no.: 6.541-5014.01-4
Rev. 6 - Date: 08.July.2004

17418

Ozone Depleting Substances Policy Statement

It is the policy of Vishay Semiconductor GmbH to

1. Meet all present and future national and international statutory requirements.
2. Regularly and continuously improve the performance of our products, processes, distribution and operating systems with respect to their impact on the health and safety of our employees and the public, as well as their impact on the environment.

It is particular concern to control or eliminate releases of those substances into the atmosphere which are known as ozone depleting substances (ODSs).

The Montreal Protocol (1987) and its London Amendments (1990) intend to severely restrict the use of ODSs and forbid their use within the next ten years. Various national and international initiatives are pressing for an earlier ban on these substances.

Vishay Semiconductor GmbH has been able to use its policy of continuous improvements to eliminate the use of ODSs listed in the following documents.

1. Annex A, B and list of transitional substances of the Montreal Protocol and the London Amendments respectively
2. Class I and II ozone depleting substances in the Clean Air Act Amendments of 1990 by the Environmental Protection Agency (EPA) in the USA
3. Council Decision 88/540/EEC and 91/690/EEC Annex A, B and C (transitional substances) respectively.

Vishay Semiconductor GmbH can certify that our semiconductors are not manufactured with ozone depleting substances and do not contain such substances.

We reserve the right to make changes to improve technical design
and may do so without further notice.

Parameters can vary in different applications. All operating parameters must be validated for each customer application by the customer. Should the buyer use Vishay Semiconductors products for any unintended or unauthorized application, the buyer shall indemnify Vishay Semiconductors against all claims, costs, damages, and expenses, arising out of, directly or indirectly, any claim of personal damage, injury or death associated with such unintended or unauthorized use.

Vishay Semiconductor GmbH, P.O.B. 3535, D-74025 Heilbronn, Germany



Notice

Specifications of the products displayed herein are subject to change without notice. Vishay Intertechnology, Inc., or anyone on its behalf, assumes no responsibility or liability for any errors or inaccuracies.

Information contained herein is intended to provide a product description only. No license, express or implied, by estoppel or otherwise, to any intellectual property rights is granted by this document. Except as provided in Vishay's terms and conditions of sale for such products, Vishay assumes no liability whatsoever, and disclaims any express or implied warranty, relating to sale and/or use of Vishay products including liability or warranties relating to fitness for a particular purpose, merchantability, or infringement of any patent, copyright, or other intellectual property right.

The products shown herein are not designed for use in medical, life-saving, or life-sustaining applications. Customers using or selling these products for use in such applications do so at their own risk and agree to fully indemnify Vishay for any damages resulting from such improper use or sale.