

## Advanced resistive touchscreen controller demonstration kit based on the STMPE811

### Introduction

This document describes the functioning of the touchscreen controller demonstration board included in the STEVAL-ICB004V1 demonstration kit. The system is designed to demonstrate the high performance resistive touch sensing capabilities of the STMPE811 touchscreen controller.

This board is also compatible with STMPE610, refer to [Section 4.11](#) for details.

**Figure 1.** Advanced resistive touchscreen controller demonstration kit



# Contents

<b>1</b>	<b>STEVAL-ICB004V1 demonstration kit description</b>	<b>6</b>
<b>2</b>	<b>Getting started</b>	<b>7</b>
2.1	Package contents	7
2.2	Hardware installation	7
2.3	Software installation	7
2.3.1	System requirements for the demonstration GUI	7
2.3.2	S-Touch™ resistive touchscreen demo GUI installation	8
2.3.3	DfuSe demonstration GUI installation	8
<b>3</b>	<b>Hardware layout</b>	<b>9</b>
<b>4</b>	<b>Hardware details</b>	<b>10</b>
4.1	Power control J5	10
4.2	Clocking Y1	10
4.3	Reset control	10
4.4	Debug JTAG interface J2	10
4.5	2-pin jumper headers J11, J12, ADC1	10
4.6	3-pin jumper headers J6,J7,J8,J9,J10	10
4.7	10-pin IDC connectors J3,J4	11
4.8	SW1 and reset switches	11
4.9	LEDs D1, D2, D3, D4	12
4.10	Touchscreen J1	12
4.11	Touchscreen controller U1	12
4.12	Microcontroller U2	12
4.13	Voltage regulators U3, U4	13
4.14	Reset supervisor U5	13
4.15	USB ESD protection U6	13
<b>5</b>	<b>Running the demonstration</b>	<b>14</b>
5.1	S-Touch™ resistive touchscreen controller demonstration (STPME811)	14
5.2	Universal dongle GUI	15

---

5.3	DfuSe demonstration .....	24
<b>6</b>	<b>Schematic diagrams for the touchscreen controller demonstration board .....</b>	<b>26</b>
<b>7</b>	<b>Bill of material .....</b>	<b>27</b>
<b>8</b>	<b>Revision history .....</b>	<b>32</b>

## List of tables

Table 1.	Board LED indications	7
Table 2.	2-pin jumper headers	10
Table 3.	3-pin jumper headers	11
Table 4.	10-pin IDC connectors	11
Table 5.	Switch description	11
Table 6.	LED description	12
Table 7.	BOM	27
Table 8.	Document revision history	32

## List of figures

Figure 1.	Advanced resistive touchscreen controller demonstration kit. . . . .	1
Figure 2.	Advanced resistive touchscreen controller demonstration board based on the STMPE811	6
Figure 3.	Hardware layout: top view . . . . .	9
Figure 4.	Hardware layout: bottom view . . . . .	9
Figure 5.	S-Touch™ resistive touchscreen demonstration (STPME811) GUI. . . . .	14
Figure 6.	Universal dongle GUI . . . . .	16
Figure 7.	Universal dongle GUI disconnect message . . . . .	16
Figure 8.	Universal dongle GUI connect message . . . . .	16
Figure 9.	Selection of I <sup>2</sup> C/SPI interface . . . . .	17
Figure 10.	I <sup>2</sup> C interface window. . . . .	17
Figure 11.	J3 interpretation for I <sup>2</sup> C interface . . . . .	18
Figure 12.	I <sup>2</sup> C pin interface in the PC GUI. . . . .	18
Figure 13.	GPIO setting window . . . . .	19
Figure 14.	GPIO mode in normal input . . . . .	19
Figure 15.	GPIO1 setting in normal input mode with interrupt. . . . .	19
Figure 16.	GPIO1 setting in push-pull output mode. . . . .	20
Figure 17.	Setting of the I <sup>2</sup> C parameters . . . . .	20
Figure 18.	I <sup>2</sup> C read/write window. . . . .	21
Figure 19.	SPI interface window . . . . .	22
Figure 20.	J3 Interpretation for SPI interface . . . . .	22
Figure 21.	SPI pin interface in PC GUI . . . . .	23
Figure 22.	Setting of SPI parameters. . . . .	23
Figure 23.	SPI read/write window . . . . .	24
Figure 24.	Circuit schematics. . . . .	26

# 1 STEVAL-ICB004V1 demonstration kit description

The board offers the added functionality of a USB universal dongle for I<sup>2</sup>C and SPI interfaces, and DFU (device firmware upgrade) protocol for run-time firmware upgrades. Multi-functionality in a single board renders the STEVAL-ICB004V1 a multi-purpose kit. The system is designed to offer users a product evaluation platform for the touchscreen controller STMPE811. Easy evaluation at the product selection stage of the system design process adds to the benefits of the system. This USB-based demonstration kit is packaged with a Windows XP<sup>®</sup>-platform STMPE811 demonstration GUI (graphical user interface) to capture writing/drawing on the touchscreen, as well as software for a universal dongle GUI for evaluation of different I<sup>2</sup>C,SPI sensors and a DFU GUI for run-time firmware upgrades.

Key features of the system include:

- A four-wire resistive touch sensing demonstration GUI
- Configurable touch sensing parameters such as touch detect delay, settling time, etc
- STMPE811 GPIO expander functionality demonstration support
- Hardware-configurable jumper headers offering flexibility and ease of interfacing the touchscreen controller in customer design
- Run-time application firmware upgrade capability using DFU

**Figure 2. Advanced resistive touchscreen controller demonstration board based on the STMPE811**

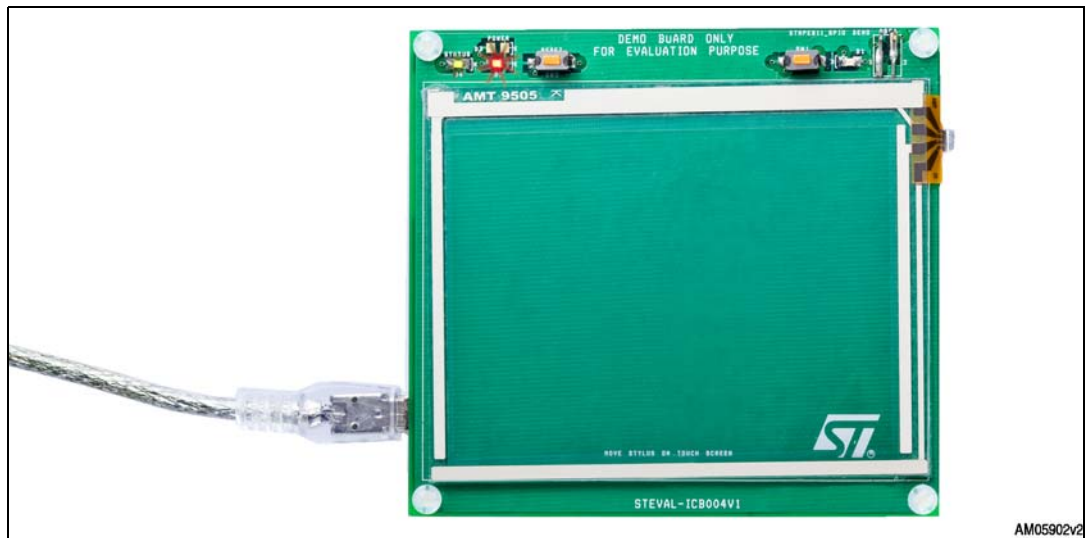

## 2 Getting started

### 2.1 Package contents

The demonstration kit includes the following items:

- Hardware:
  - STEVAL-ICB004V1 demonstration board
  - USB A to mini-B cable
  - Stylus pen
  - IDC cable for 10-pin IDC connectors
- Software:
  - S-Touch™ resistive touchscreen controller demonstration (STPME811)
  - DfuSe demonstration GUI
- Documentation:
  - User manual
  - Presentation
  - Schematic
  - Bill of materials (BOM)

### 2.2 Hardware installation

The demonstration kit is powered through the USB A to mini-B cable included in the kit. Using this cable, connect the demonstration board to the PC using the on-board J5 connector. Since the system demonstration makes use of a PC GUI, the USB connection works to power the board and for data transfer.

Status LEDs provide indications of the power-up status of the board.

**Table 1. Board LED indications**

LED	ON	OFF
D3	Power successful	Power unsuccessful
D4	Application boot-up successful	Application boot-up unsuccessful

### 2.3 Software installation

The demonstration kit supports two different functionalities based on the PC GUI, defined as the following two modes of operation:

- S-Touch™ resistive touchscreen demonstration: STMPE811-based writing pad
- DfuSe demonstration GUI: run-time firmware upgrade of the MCU

#### 2.3.1 System requirements for the demonstration GUI

For demonstration board communication with the GUI, a later version of Windows, such as Windows XP, must be installed on the PC.

*Note:* The version of the Windows OS installed on the PC can be determined by clicking on the system icon in the control panel.

### 2.3.2 S-Touch™ resistive touchscreen demo GUI installation

- The S-Touch™ resistive touchscreen controller demonstration GUI package is made up of two GUI applications:
  - The S-Touch™ resistive touchscreen controller demonstration (STPME811)
  - A Universal dongle GUI

Both GUI applications for the S-Touch™ resistive touchscreen demonstration GUI are based on ST vendor-specific protocols.

- Steps for GUI installation:
  - Install the S-Touch™ resistive touchscreen demonstration GUI setup included in the kit.
  - Two application GUIs are installed at path: C:\Program Files\STMicroelectronics\S-Touch™ resistive touchscreen controller demo (default path).
  - After package installation, connect the board.
  - On board connection, the PC prompts for driver installation.
  - Browse to the driver available at path: C:\Program Files\STMicroelectronics\S-Touch resistive touchscreen Demo\Driver
  - The S-Touch™ resistive touchscreen controller demo GUI installation is complete. Open the application GUI of interest and run the demo.

### 2.3.3 DfuSe demonstration GUI installation

The DFU setup is available on [www.st.com](http://www.st.com) using search keywords “source file for DfuSe getting started”, or the setup file can be accessed directly through the following hyperlink:

[www.st.com/stonline/products/support/micro/files/um0412.zip](http://www.st.com/stonline/products/support/micro/files/um0412.zip)

Link name: Source file for DfuSe getting started

Filename: UM0412.zip

- Steps for the DfuSe GUI demonstration:
  - Perform the software installation from [www.st.com](http://www.st.com)
  - Run the installation on the PC
  - On board connection to PC for DFU, a separate driver is required
  - The driver for the DFU is available in the installation folder (default path: C:\Program Files\STMicroelectronics\DfuSe driver)

For more details regarding DfuSe installation and operation, refer user manual UM0412 available at C:\Program Files\STMicroelectronics\DfuSe\Sources\Doc

Following the successful installation of the GUI and requisite drivers and after connecting the board to the PC, open the required demonstration GUI to run the demonstration.



### 3 Hardware layout

The demonstration kit hardware is designed using a sectional approach to offer multiple functionalities to users.

**Figure 3. Hardware layout: top view**

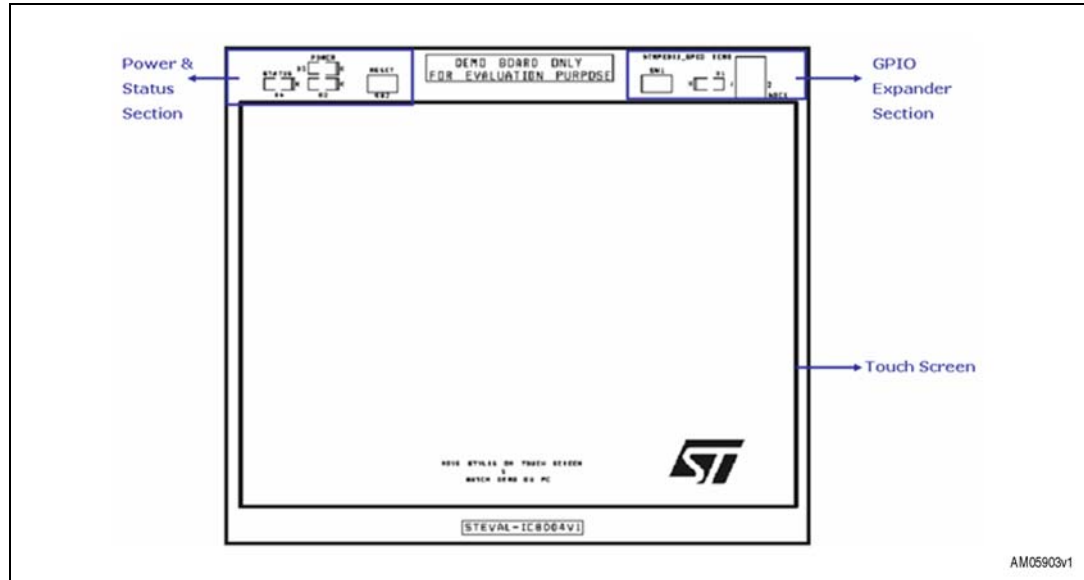

AM05903v1

**Figure 4. Hardware layout: bottom view**

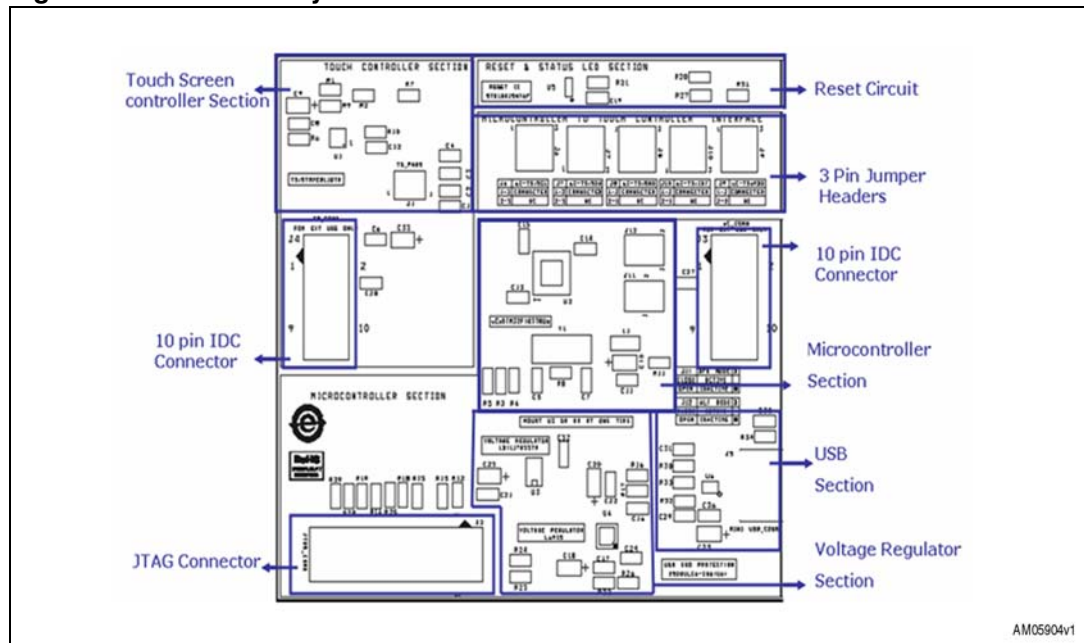

AM05904v1

## 4 Hardware details

### 4.1 Power control J5

The demonstration board can be powered from the USB connector J5. All other required voltages are provided by the on-board voltage regulator.

### 4.2 Clocking Y1

The clock source available on the demonstration board is Y1: 8 MHz crystal for microcontroller STM32F103T8U6.

### 4.3 Reset control

The reset can be generated by hardware or software

- Reset button: activates the RESET input of the microcontroller when pressed
- JTAG reset

### 4.4 Debug JTAG interface J2

Software debug is performed via the standard ARM<sup>®</sup> JTAG connection: J2 - 20-pin IDC (insulation displacement connector) for connection to the standard ARM host interface.

### 4.5 2-pin jumper headers J11, J12, ADC1

2-pin jumper headers are used for firmware mode selection.

**Table 2. 2-pin jumper headers**

Jumper	Open	Close	Default
J11	Application mode active	DFU mode active	Open
J12	Main application mode active	Alternative application mode active	Open
ADC1	Touchscreen controller ADC input is not connected to GND	Touchscreen controller ADC input is connected to GND	Open

To work with the DfuSe demonstration GUI, J11 should be closed. J12 and ADC1 are mounted for future user requirements only.

### 4.6 3-pin jumper headers J6,J7,J8,J9,J10

3-pin jumper headers are used for connection between the touchscreen controller the STMPE811 I<sup>2</sup>C lines and the microcontroller STM32F103T8U6 I<sup>2</sup>C lines.

These jumper headers are available to the user to manage the connection/disconnection of the touchscreen controller to/from the microcontroller on run-time.

**Table 3. 3-pin jumper headers**

Jumper	Close: 1-2	Close: 2- 3	Default
J6	STM32 I <sup>2</sup> C clock line is connected to STMPE811 I <sup>2</sup> C clock line	STM32 I <sup>2</sup> C clock is not connected to STMPE811 I <sup>2</sup> C clock line	Close: 1-2
J7	STM32 I <sup>2</sup> C data line is connected to STMPE811 I <sup>2</sup> C data line	STM32 I <sup>2</sup> C data line is not connected to STMPE811 I <sup>2</sup> C data line	Close: 1-2
J8	STM32 GND line is connected to STMPE811 GND line	STM32 GND line is not connected to STMPE811 GND line	Close: 1-2
J9	STM32 VDD line is connected to STMPE811 VDD line	STM32 VDD line is not connected to STMPE811 VDD line	Close: 1-2
J10	STM32 interrupt line is connected to STMPE811 interrupt line	STM32 interrupt line is not connected to STMPE811 interrupt line	Close: 2-3

## 4.7 10-pin IDC connectors J3,J4

10-pin IDC connectors are available on the board for evaluation of the touchscreen controller in the users own design.

**Table 4. 10-pin IDC connectors**

Connector	Description
J3	Connector header for interface to I <sup>2</sup> C and SPI lines of microcontroller STM32F103T8U6
J4	Connector header for interface to I <sup>2</sup> C lines of touchscreen controller STMPE811

Using J3, users can connect the touchscreen controller to their own design using the 10-pin IDC cable. Using J4, the user can work with other I<sup>2</sup>C/SPI sensors, such as the touchscreen controller demo, MEMS, digital temperature sensors, etc. with the 10-pin IDC cable using the universal dongle GUI.

## 4.8 SW1 and reset switches

**Table 5. Switch description**

Switch	Description
SW1	Demonstrates GPIO expander functionality of touchscreen controller STMP811
RESET	Generates microcontroller STM32 reset for the board

With the S-Touch™ resistive touchscreen demo GUI, the GPIO expander function of the STMPE811 is demonstrated. When SW1 is pressed, the LED glows in the GUI window.

## 4.9 LEDs D1, D2, D3, D4

**Table 6. LED description**

LED	Description
D1	Demonstrates GPIO expander functionality
D2	Shows power status of the board
D3	Shows power status of the board
D4	Shows application status of the board

The board provides hardware support for two voltage regulators, U3 and U4. Only one is mounted at one time. D2 & D3 are power LEDs for the respective voltage regulators.

## 4.10 Touchscreen J1

The 4-wire 3.8" resistive touchscreen is mounted on the board for touch sensing demonstration using the S-Touch™ resistive touchscreen controller demo GUI.

## 4.11 Touchscreen controller U1

The STMPE811 (4-wire resistive touchscreen controller) is interfaced with the 4-wire touchscreen J1. It is responsible for converting touch events on the touchscreen to digital touch coordinates. The STMPE811 supports SPI and I<sup>2</sup>C interfacing. Here, the STMPE811 is interfaced with the microcontroller using the I<sup>2</sup>C interface.

The STEVAL-ICB004V1 board also supports the STMPE610 touchscreen controller device. The STMPE610 features touch sensing and 6-line GPIO port expander functionality, while the STMPE811 supports touch sensing with 8-line GPIO expander functionality. Both are pin-to-pin compatible, but in the STMPE610, pin number 8 is NC and pin number 9 has limited functionality compared to the STMPE811. Therefore, if the STMPE610 is used in the STEVAL-ICB004V1, switch SW1 (pin 8 of The STMPE811) does not function. However, touch sensing and all remaining GPIOs are fully functional on the board with the STMPE610. To demonstrate the capabilities of the STMPE610 using the STEVAL-ICB004V1 board, simply replace component U1 (STMPE811) with the STMPE610.

## 4.12 Microcontroller U2

The STM32F103T8U6 (STM32 Performance Line 36-pin, 64 K Flash, 20 K RAM) MCU is used to provide the USB interface between touchscreen controller STMPE811 and the PC GUI.

### 4.13 Voltage regulators U3, U4

- U3: LD1117D33TR (low drop fixed positive voltage, 3.3 V regulator) is used to convert the USB 5 V to VDD 3.3 V.
- U4: L6935 (ultra low drop output linear regulator, 3 V, output current up to 3 A) is used to convert the USB 5 V to VDD 3 V. Only one regulator is mounted at one time on the board. The board can operate at both 3 V and 3.3 V.

### 4.14 Reset supervisor U5

The STM1001SWX6F (reset circuit, open drain output, reset threshold 2.93 V and VRST = 2.85 V to 3.00 V) is used as a reset supervisor on the board for perfect reset management.

### 4.15 USB ESD protection U6

The ESDAULC6-3BP6 (ESD protection for high-speed interface, USB ESD protection) is used as an ESD protection IC for the USB circuit.

## 5 Running the demonstration

### 5.1 S-Touch™ resistive touchscreen controller demonstration (STPME811)

The following represents the default demonstration configuration of the demonstration kit.

#### Demo application:

- The S-Touch™ resistive touchscreen controller demonstration (STPME811) maps the stylus movement on the resistive touchscreen to the GUI window on the PC. This offers a real-time writing/drawing experience to the user.
- The STMPE811 touchscreen controller also has GPIO expander capability. When switch SW1 on the board is pushed, the LED on the GUI glows.
- The writing pad demonstration forms the basis for resistive touch sensing applications like signature capture, portable paintbrush, and resistive scroll pads in laptops.

**Figure 5. S-Touch™ resistive touchscreen demonstration (STPME811) GUI**

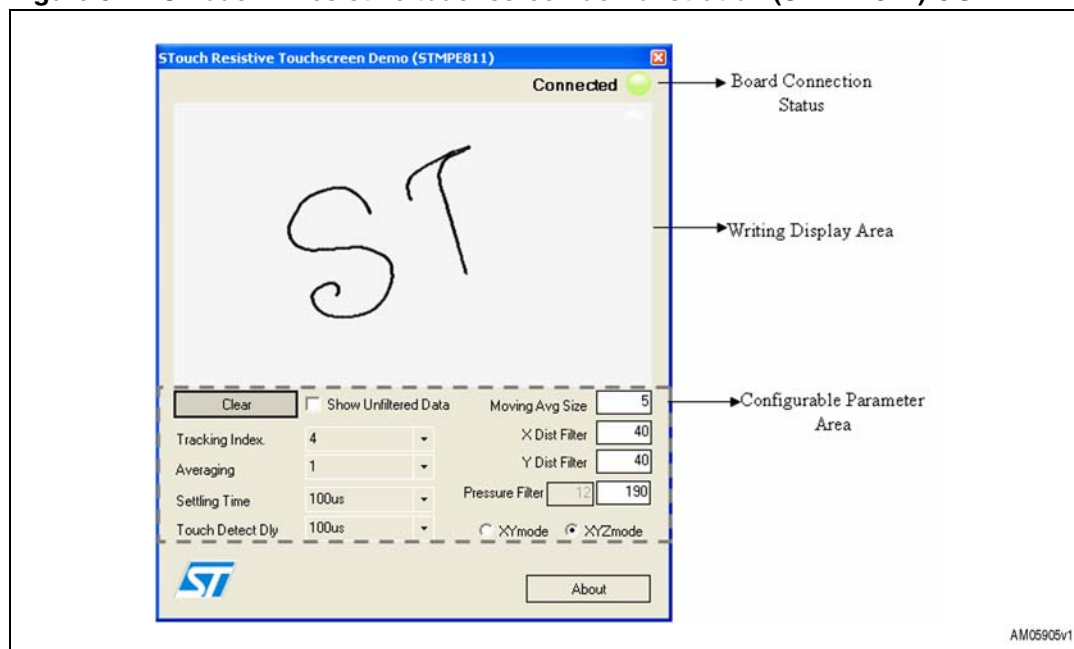

#### Features:

- Easy-to-use GUI interface with board connection status display
- Capability to show touch movement with and without filtering
- Configurable touchscreen controller parameters:
  - Tracking index
  - Averaging
  - Settling delay
  - Touch detect delay

- Moving average size
- Direction choice: XY/XYZ
- Axis distance filters

**How it works:**

- Perform the PC GUI installation as described in the software installation section
- Ensure that J6, J7, J8 and J9 are connected with position 1-2 closed, and J11 open
- Connect the board to the PC for the demonstration
- Open the S-Touch™ resistive touchscreen controller demonstration (STPME811) GUI
- Move the stylus on the touchscreen and enjoy the writing demonstration on the PC GUI
- If desired, configure the touch sensing parameters on-the-fly to demonstrate their effects.

## 5.2 Universal dongle GUI

In the same default mode configuration, the demonstration kit supports universal dongle GUI functionality. Here, the I<sup>2</sup>C and SPI interfaces (both with GPIO), are available for interfacing any digital sensor, such as other touchscreen controllers, using the J3 connector in the microcontroller section.

**Demo application:**

- The universal dongle GUI allows the user to evaluate various I<sup>2</sup>C and SPI sensors using connector header J3 (microcontroller I<sup>2</sup>C and SPI interface) and microcontroller STM32 as host
- Only one interface can be used at a time I<sup>2</sup>C or SPI, as both are multiplexed on the same 10-pin header (J3) to save board space.

**Features:**

- The PC GUI-based USB dongle is a rapid prototyping tool for I<sup>2</sup>C/SPI sensors
- Capability to map I<sup>2</sup>C/SPI sensor data to USB, and vice-versa, for easy evaluation of sensor interfacing
- Along with I<sup>2</sup>C/SPI interfacing, GPIOs are also available on the same header (J3) to act as control lines for the sensor
- Here, PC GUI DLL files for I<sup>2</sup>C and SPI interfaces are also provided, so users can utilize these DLL files to make their own customized PC GUI as per specific requirements. The board acts as a tool to allow end-users to focus solely on application development because the complexity of the microcontroller is handled by the tool itself, thereby increasing efficiency and reducing time-to-market.

**How it works:**

- Installation is done as part of the S-Touch™ resistive touchscreen controller demonstration GUI installation
- Ensure that J6, J7, J8, J9 are connected in position 2-3 closed, and J11 is open
- On starting the universal dongle GUI on the PC, the user sees a graphical interface for controlling the demonstration board. This PC software is used to issue various commands and to control data transfer

**Figure 6. Universal dongle GUI**

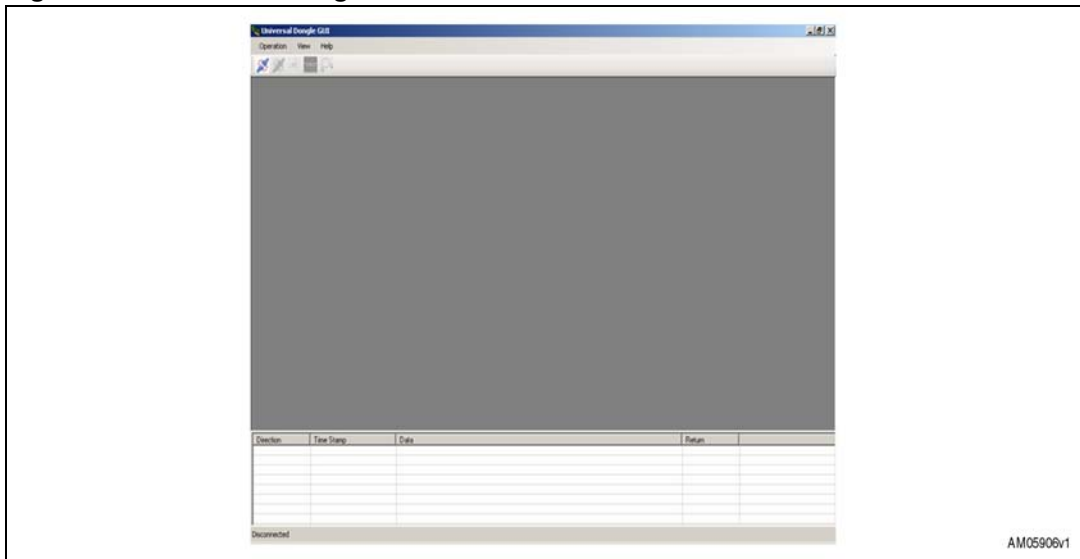

- Users can check whether or not the board is connected by clicking the connection check button. If the board is not connected, then the user sees the following message

**Figure 7. Universal dongle GUI disconnect message**



If the board is connected, then following message appears.

**Figure 8. Universal dongle GUI connect message**



- Once this is complete, the PC GUI is properly connected to the demonstration board and ready for use.



**Using I<sup>2</sup>C interface:**

- To connect the I<sup>2</sup>C interface, first select “Synchronous” from the “Operation” menu
- Once the synchronous interface is selected, an additional menu for the synchronous interface allows selection between I<sup>2</sup>C and SPI interfaces (see [Figure 9](#)).

**Figure 9. Selection of I<sup>2</sup>C/SPI interface**

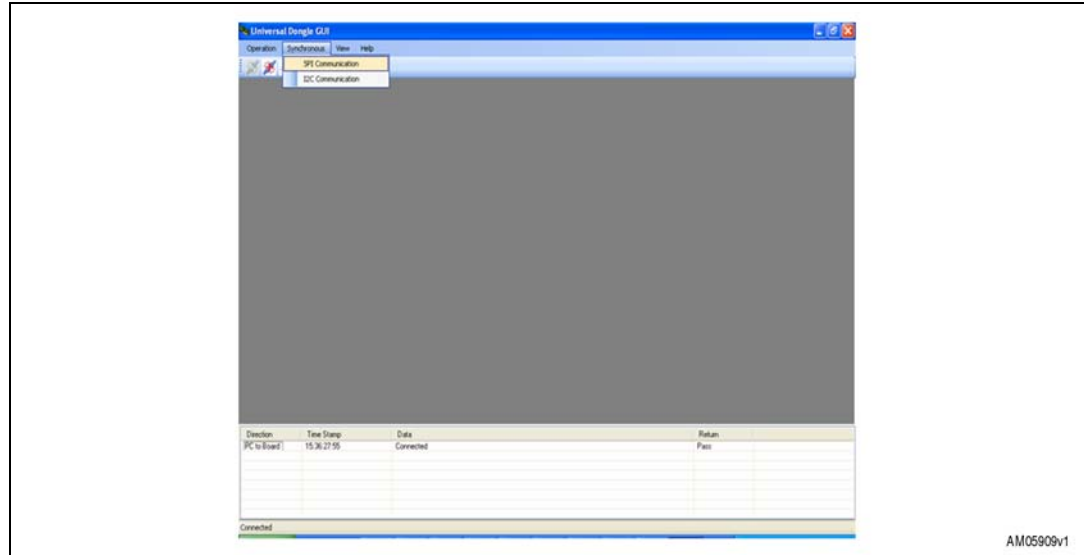

- Selection of the I<sup>2</sup>C interface option opens a window for I<sup>2</sup>C interface control, as shown in [Figure 10](#).
- At this point, the PC GUI is ready to be used for testing I<sup>2</sup>C-based slave devices. To use any I<sup>2</sup>C-based slave, refer to the IDC connector J3 illustration shown in [Figure 11](#).

**Figure 10. I<sup>2</sup>C interface window**

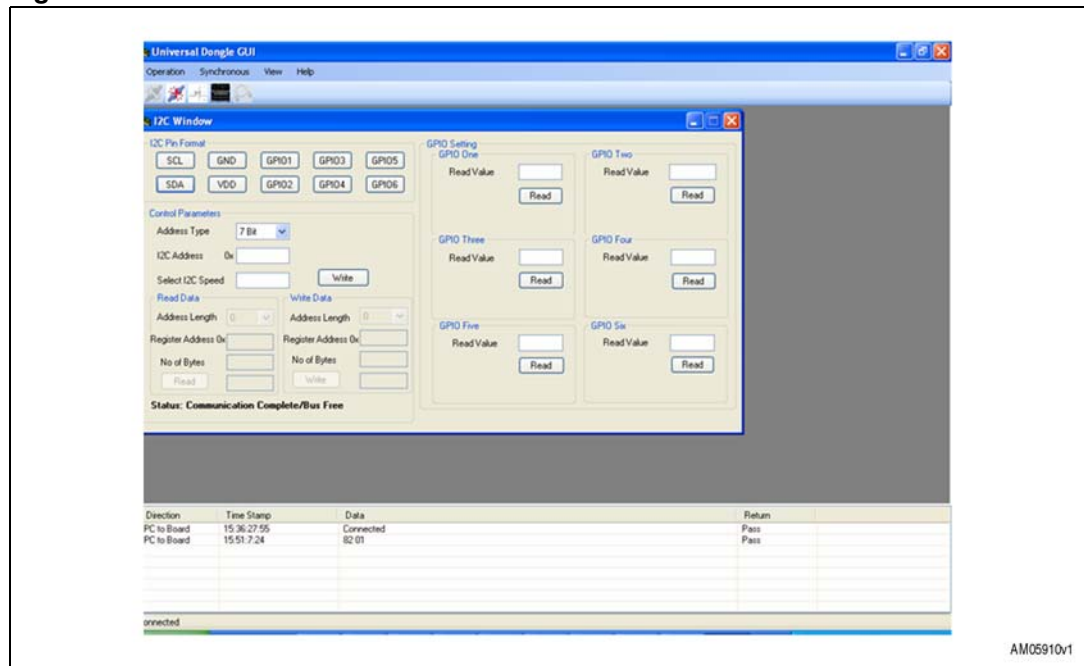
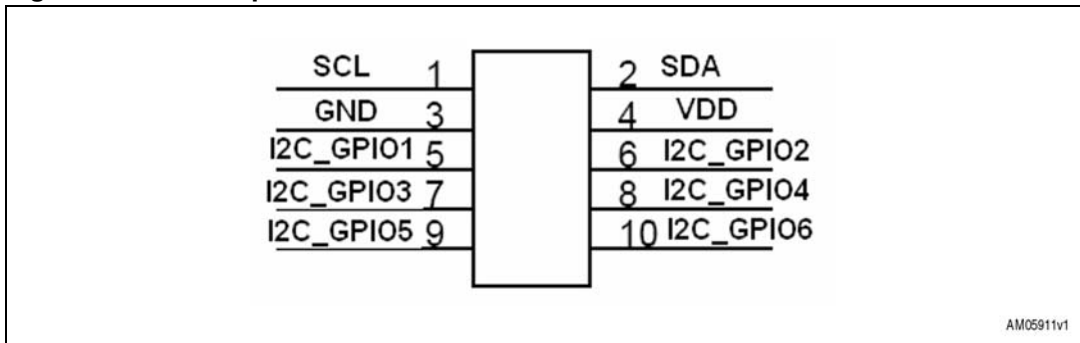
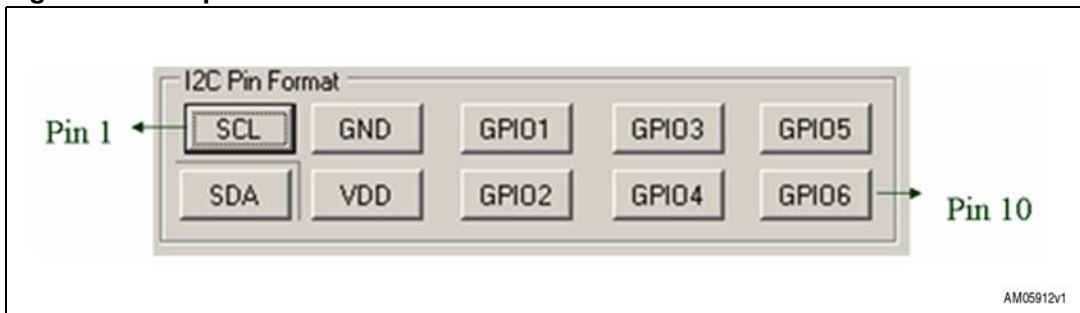

Figure 11. J3 interpretation for I<sup>2</sup>C interface



- I<sup>2</sup>C GPIO settings:
  - GPIOs may be required for sensor slave interfacing to the host, along with I<sup>2</sup>C protocol line connections. The GPIO pins may act as control lines, like chip select, status line, interrupt line, etc. Therefore, one should set the GPIOs accordingly.
  - Before making the connection to J3, the GPIOs should be set properly.
  - GPIO setting can be performed by clicking the I<sup>2</sup>C pin interface as shown in [Figure 12](#).

Figure 12. I<sup>2</sup>C pin interface in the PC GUI



- Here, one can set only the GPIOs mentioned. The I<sup>2</sup>C lines and power lines are fixed. To perform the settings of a GPIO, simply click on that GPIO. Once clicked, a setting window opens, as shown in [Figure 13](#)

Figure 13. GPIO setting window



- By selecting the option in the GPIO setting window, one can set the GPIO to different modes, such as simple input mode, input with interrupt and push-pull output mode
- If the GPIO is selected in normal input mode, one sees the GPIO1 window, as in [Figure 14](#). If the “Read” button is clicked, one sees the GPIO1 value as '0' or '1'.

Figure 14. GPIO mode in normal input

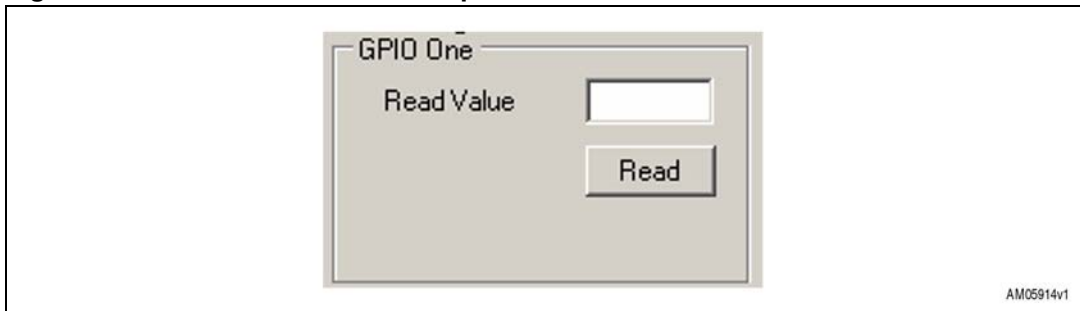

- Now, if one selects the GPIO in normal input mode with interrupt, the GPIO1 window shown in [Figure 15](#) is displayed. In addition to the input mode interface, a green LED is displayed if there is an interrupt condition, and a red LED is shown if there is no interrupt condition.

Figure 15. GPIO1 setting in normal input mode with interrupt

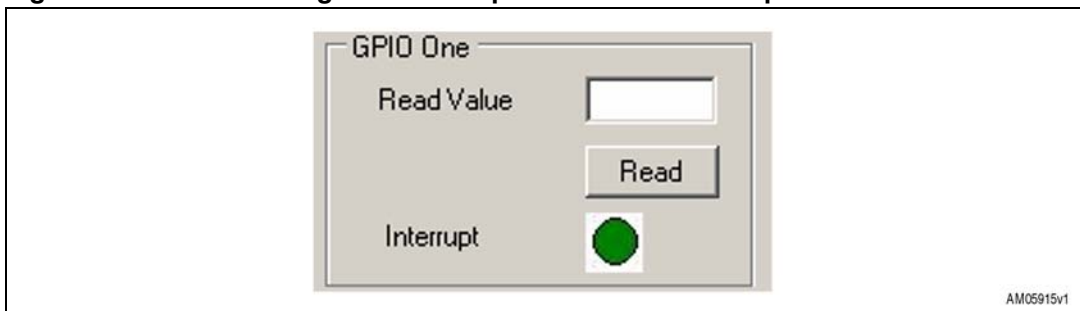

- If the GPIO in push-pull output mode is selected, the GPIO1 window shown in [Figure 16](#) is displayed. One needs to enter a value of 0 or 1 and click the “Write” button to make the GPIO LOW and HIGH, respectively.

Figure 16. GPIO1 setting in push-pull output mode

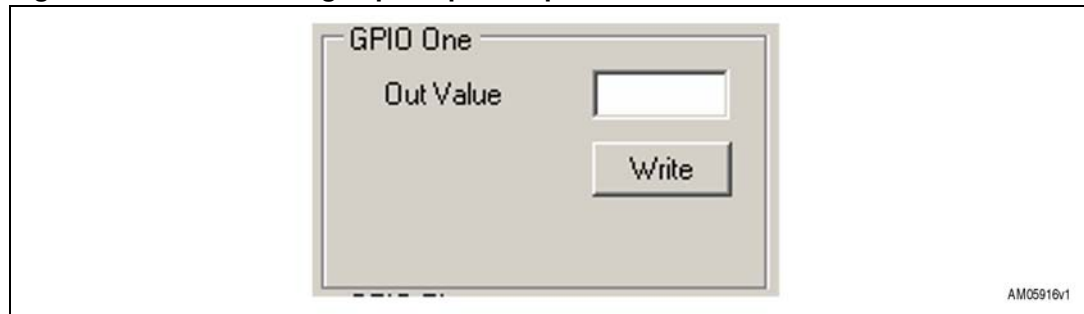

Note: For this kit, GPIO with PWM mode is not supported.

- I<sup>2</sup>C header settings
  - Once the GPIO settings are complete, the daughter board can be connected to the demonstration board, and it can be assumed that the user has performed the setting of the daughter board control and status lines correctly. Before the I<sup>2</sup>C communication can be used, some parameters need to be defined (see [Figure 17](#)).

Figure 17. Setting of the I<sup>2</sup>C parameters

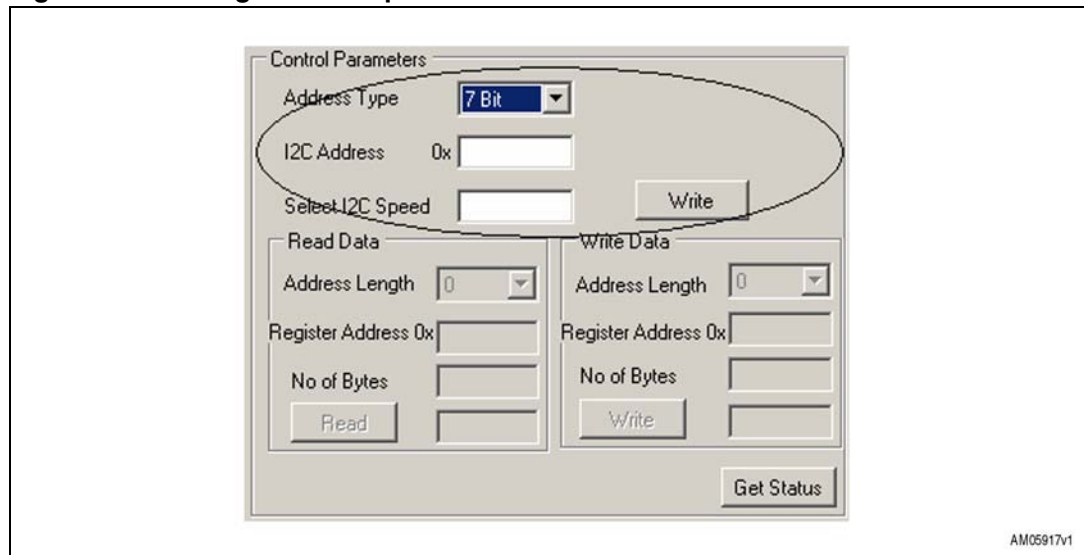

- These parameters include selection of I<sup>2</sup>C address types (7-bit or 10-bit), the I<sup>2</sup>C slave device address and I<sup>2</sup>C speed.
- Once the selection is done, click the “Write” button. This sets the I<sup>2</sup>C interface and renders the system ready to read or write the data from the I<sup>2</sup>C slave device connected to the demonstration board. Once done, the control settings part is frozen and the “Write” button becomes a “Reset” button, the purpose of which is to reset the I<sup>2</sup>C settings.

The read/write window is shown in [Figure 18](#).

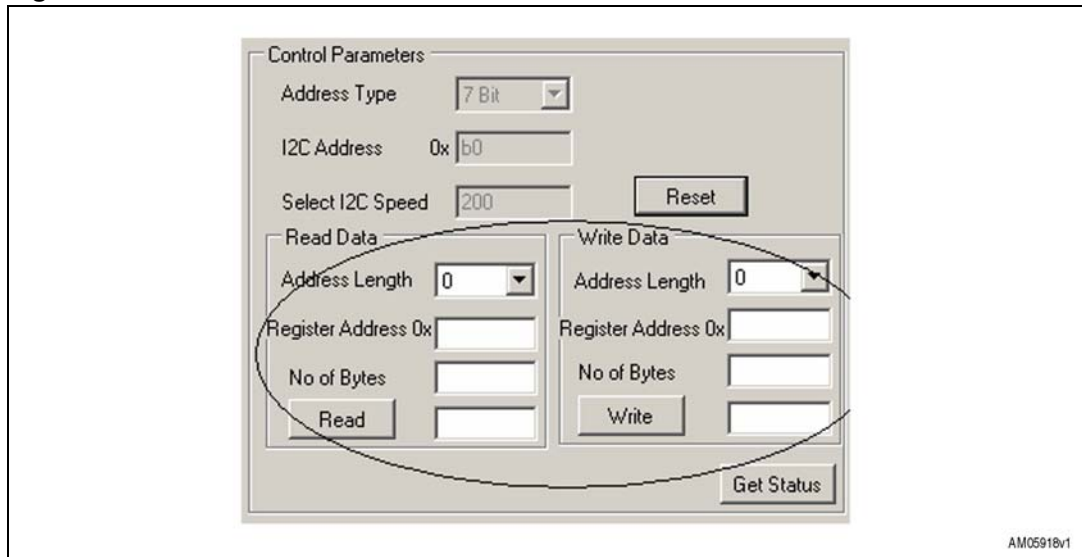
Figure 18. I<sup>2</sup>C read/write window

- Here, depending on the slave device, the register address length can be selected (from 0 to 4 bytes, 0 byte length is used for random read and write operations)
- After every read or write operation, the GUI updates the status in the status portion (e.g. status: communication complete / bus free) so that one can check the status of the I<sup>2</sup>C communication occurring between the demonstration board and the I<sup>2</sup>C slave daughter board.

Thus, this interface allows users to connect any I<sup>2</sup>C interface-based slave device and carry out testing.

- Using the SPI interface
  - To connect the SPI interface, select “Synchronous” in “Operation” table, and SPI in the Synchronous tab. The window shown in [Figure 19](#) opens.

Figure 19. SPI interface window

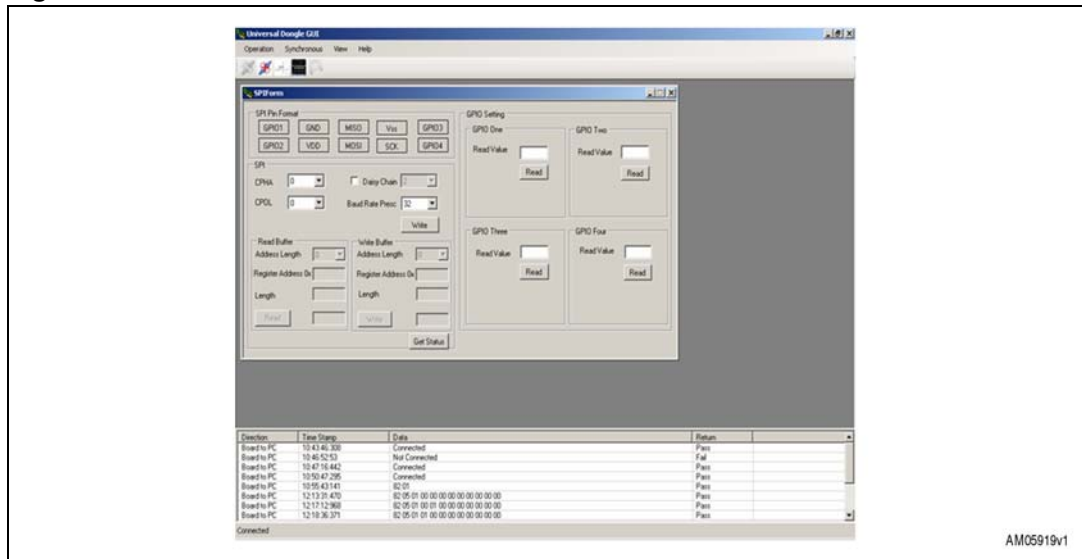

- At this point, the PC GUI is ready to be used for testing SPI-based slave devices. However, before it can be used the connection to jumper J3, as shown in [Figure 20](#), must be made.

Figure 20. J3 Interpretation for SPI interface

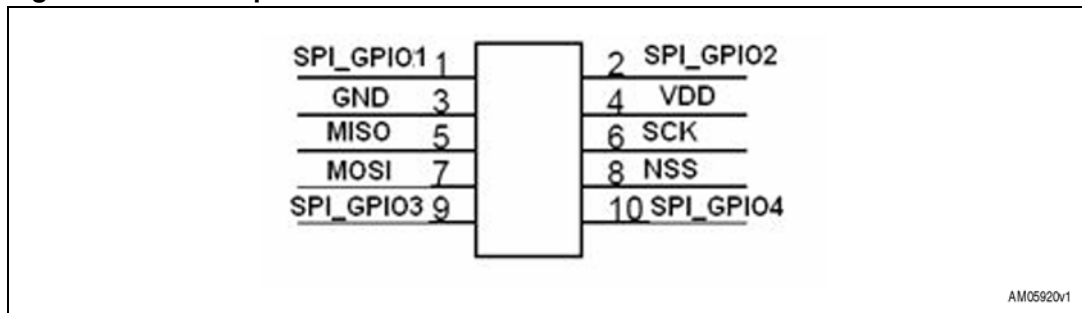

- SPI GPIO settings”
  - Before making the connection to J3, one needs to properly set the GPIOs which are to be used along with the SPI interface. These may be control lines, chip select or status line, such as interrupt line, so one needs to set the GPIOs accordingly. This can be done by clicking the SPI pin interface as shown in [Figure 21](#).

Figure 21. SPI pin interface in PC GUI

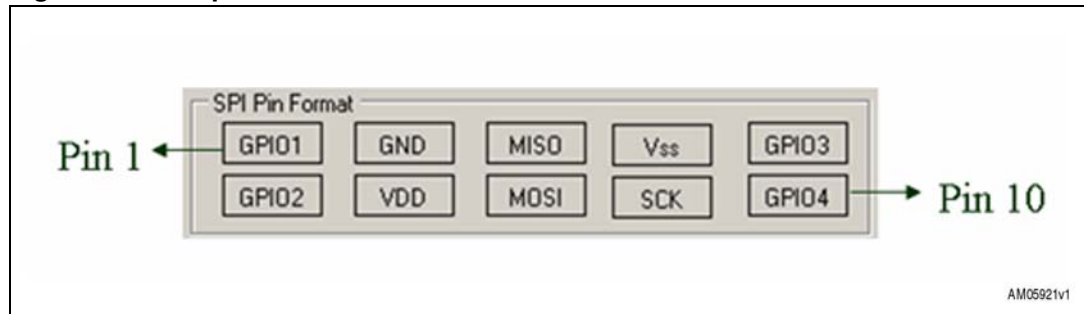

- Follow the instructions in the I<sup>2</sup>C GPIO setting section to perform the GPIO settings.

*Note:* In this case, only GPIO1 and GPIO2 are unavailable in the default hardware configuration. R3 and R5 should be de-soldered if using SPI GPIO1 and SPI GPIO2.

- SPI header settings:
  - Once the GPIO settings are complete, the daughter board can be connected to the demonstration board and it can be assumed that the user has correctly performed the setting of the daughter board control and status lines. Before one can use the SPI communication, some parameters, as shown in [Figure 22](#), should be defined.

Figure 22. Setting of SPI parameters

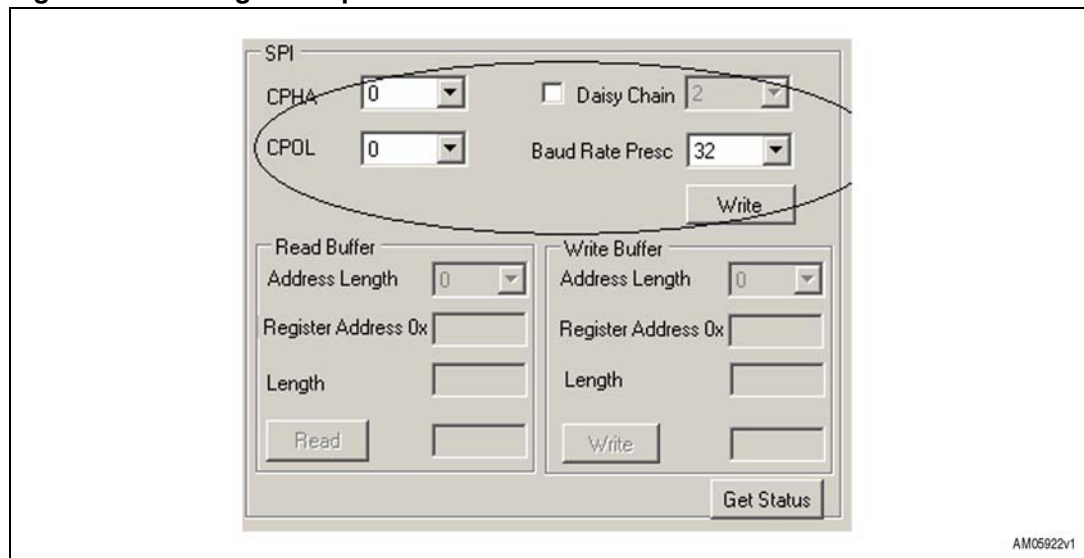

- Parameters include selection of CPHA, CPOL, and baud rate prescaler selection. (By default, the most significant bit is put first). Once the selection is complete, click the "Write" button. This sets the SPI interface and prepares the system to read or write the data from the SPI interface-based daughter board connected to the demonstration board. Once this is complete, the control settings part is frozen and the "Write" button becomes a "Reset" button, the purpose of which is to reset the SPI settings.

Figure 23. SPI read/write window

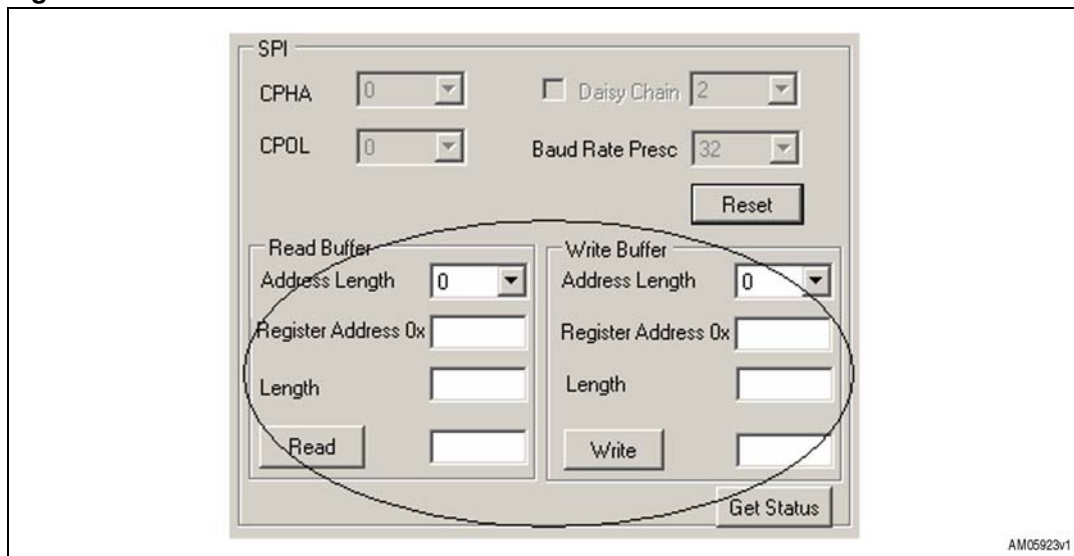

- So depending on the slave device, the user can select the register address length (from 0 to 4 bytes; 0 byte length is used for random read and write operations). After every read or write operation, the GUI updates the status in the status portion (e.g. status: communication complete / bus free) so that one can check the status of the SPI communication occurring between the demonstration board and the SPI slave daughter board. Thus this interface allows one to connect any SPI interface-based slave device.

*Note:* With this board, GPIO configuration input with PWM and asynchronous communication using USART is not available.

### 5.3 DfuSe demonstration

The DfuSe demonstration represents additional functionality in the demonstration kit.

**Demo application:**

- The DfuSe GUI allows application firmware upgrade on the board during run-time.
- Users can develop their own application firmware, or make modifications to existing firmware.

Then user can program a new workspace using the DfuSe GUI with a USB-to-PC interface.

**Features:**

- Due to the embedded DFU functionality in the board firmware, JTAG programming is not required for firmware upgrade.
- The DFU layer is the startup layer for the firmware execution. In the DFU layer, a jump to the application layer is executed.
- DFU also supports upload of application firmware to the PC.



**How it works:**

- Install the DfuSe GUI as described in the software installation section DfuSe demonstration GUI installation
- To work in DFU mode, connect jumper J11
- Open the DfuSe GUI and perform the firmware upgrade as per requirements

*Note: For more details regarding DfuSe operation, refer to user manual UM0412 available at C:\Program Files\STMicroelectronics\DfuSe\Sources\Doc after DfuSe GUI installation.*

# 6 Schematic diagrams for the touchscreen controller demonstration board

Figure 24. Circuit schematics

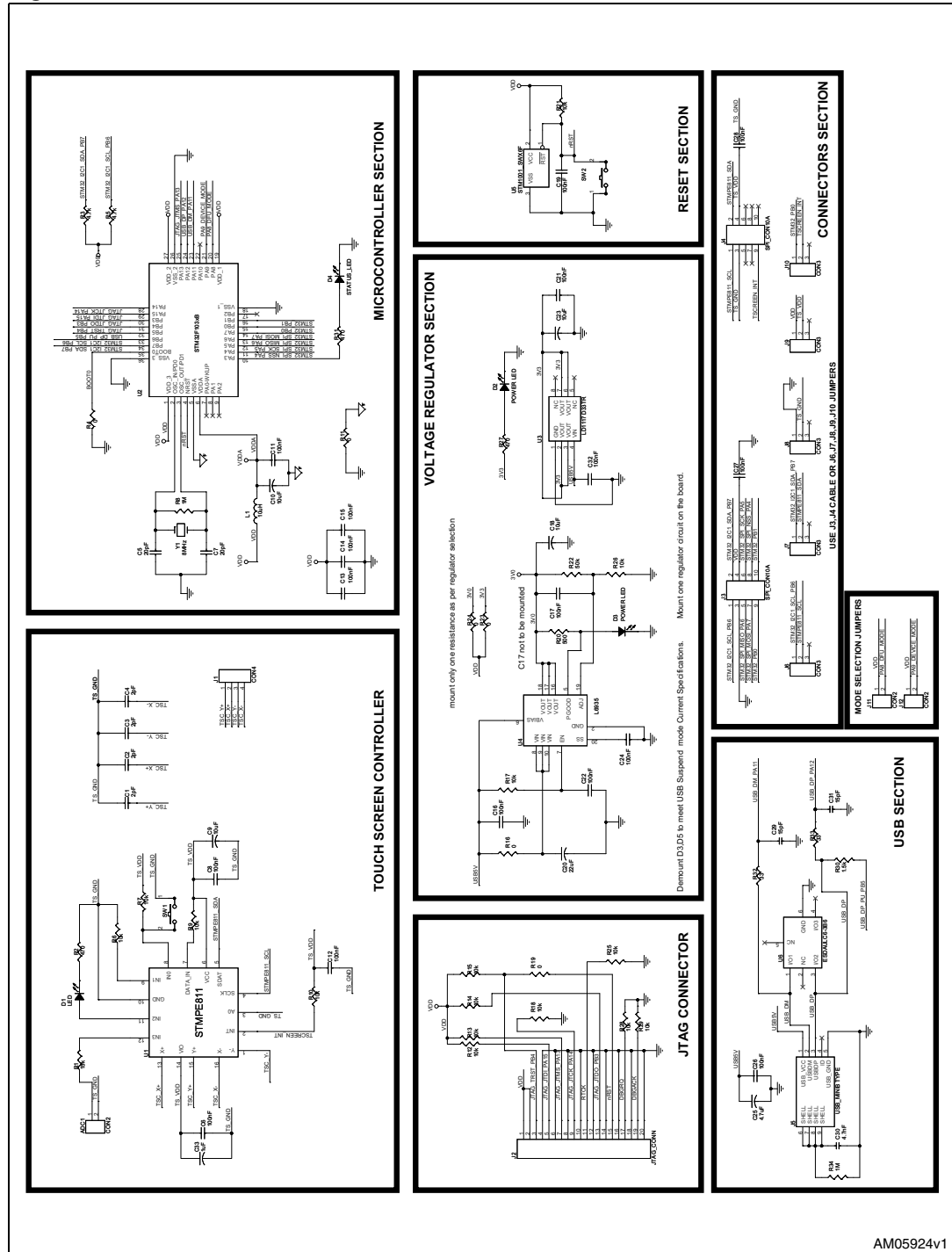

AM05924v1



## 7 Bill of material

Table 7. BOM

Category	Ref. des.	Component description	Package	Manufacturer	Manufacturer's order code / orderable part number	Supplier	Supplier order code or equivalent
ST devices	U1	4-wire resistive touchscreen controller	QFN16	STMicroelectronics	STMPE811QTR		
	U2	STM32 performance line 36-pin, 64 k $\Omega$ Flash, 20 k $\Omega$ RAM	VFQFPN36	STMicroelectronics	STM32F103T8U6		
	U3	Low drop fixed positive voltage, 3.3 V regulators	SO-8	STMicroelectronics	LD1117D33TR		
	U4	Ultra low drop output linear regulator, 3 V, output current up to 3 A	VFQFPN20	STMicroelectronics	L6935		
	U5	Reset circuit, open drain output, reset threshold 2.93 V (VRST = 2.85 V to 3.00 V)	SOT23-3 (WX)	STMicroelectronics	STM1001SWX6F		
	U6	ESD protection for high speed interface, USB ESD protection	SOT-666	STMicroelectronics	ESDAULC6-3BP6		
Crystal and oscillator	Y1	Quartz crystal 8 MHz	SMD	ECS Inc	ECS-80-S-5PX-TR	Digi-Key	XC1243CT-ND

Table 7. BOM (continued)

Category	Ref. des.	Component description	Package	Manufacturer	Manufacturer's order code / orderable part number	Supplier	Supplier order code or equivalent
Connectors and jumpers	J2	Box header, surface mount, 20-way, 2x10 pin, 2.54 mm x 2.54 mm pitch	SMD	SAMTEC	HTST-110-01-L-DV		
	J3,J4	box header, surface mount, 10-way, 2x5 pin, 2.54 mm x 2.54 mm pitch	SMD	SAMTEC	HTST-105-01-L-DV		
	J5	USB mini-B type connector	SMD	SAMTEC	MUSB-05-S-B-SM-A		
	J6,J7,J8,J9,J10, J11,J12	Pin header, surface mount, 3 pin, 2.54 mm pitch	SMD	Protectron	P9107-40-03-1		
LEDs	D1,D2,D3	LED	SMD0805		Any		



Table 7. BOM (continued)

Category	Ref. des.	Component description	Package	Manufacturer	Manufacturer's order code / orderable part number	Supplier	Supplier order code or equivalent
Capacitors	C1,C2,C3,C4	2 pF	Ceramic SMD		Any		
	C5,C7	20 pF	Ceramic SMD		Any		
	C6,C8,C11,C12, C13,C14,C15, C16,C17,C19, C21,C22,C24, C26,C27,C28, C32	100 nF	Ceramic SMD		Any		
	C33	1 $\mu$ F/25 V tantalum SMD	EIA 3216-18/size A		Any		
	C9,C10,C18,C23	10 $\mu$ F/25 V tantalum SMD	EIA 3216-18/size A		Any		
	C20	22 $\mu$ F/25 V tantalum SMD	EIA 3216-18/size A		Any		
	C25	4.7 $\mu$ F/25 V tantalum SMD	EIA 3216-18/size A		Any		
	C29,C31	15 pF	Ceramic SMD		Any		
	C30	4.7 nF	Ceramic SMD		Any		



Table 7. BOM (continued)

Category	Ref. des.	Component description	Package	Manufacturer	Manufacturer's order code / orderable part number	Supplier	Supplier order code or equivalent
Resistors	R1	15 k $\Omega$	SMD		Any		
	R2,R27,R31	470 $\Omega$	SMD		Any		
	R3,R5	4.7 k $\Omega$	SMD		Any		
	R4,R11,R16,R19, R23,R24	0	SMD		Any		
	R6,R7,R9,R10, R12,R13,R14, R15,R17,R18, R21,R25,R26, R28,R29	10 k $\Omega$	SMD		Any		
	R8,R34	1 M $\Omega$	SMD		Any		
	R20	500 $\Omega$	SMD		Any		
	R22	50 k $\Omega$	SMD		Any		
	R30	1.5 k $\Omega$	SMD		Any		
	R32,R33	33 $\Omega$	SMD		Any		
Inductors	L1	10 $\mu$ H	SMD		Any		



**Table 7. BOM (continued)**

Category	Ref. des.	Component description	Package	Manufacturer	Manufacturer's order code / orderable part number	Supplier	Supplier order code or equivalent
Misc components	SW1, SW2	Push button switch, SMD	Tactile switch, SPNO, SMD. 6 mm x 3.5 mm	MULTICOMP	DTSM-32S-B	Farnell	Part# 9471898
	Touchscreen	4-wire resistive touchscreen	ITO glass sheet 1.1 FPC/ZIF	Apex material technology corp.	AMT 9505	Electrotest Pte Ltd.	AMT 9505
	USB mini B cable	USB cable: USB A to mini-B connector	Length = 915 mm	SPC technology	SPC20060	Farnell	Part# 1651027
	Command strips	Adhesive touchscreen mounting strips	Length=190 mm	3 M $\Omega$	Command (TM) strips	Electrotest Pte Ltd.	Command strips
	Touchscreen stylus	Resistive touchscreen stylus	Stylus pen			Electrotest Pte Ltd.	PenMount stylus pen
	IDC cable	Cable for IDC 5*10 connectors (IDC connector: box header, 10-way, 2x5 pin, 2.54 mm x 2.54 mm pitch)	Length=5"	SAMTEC	HCSD-05-D-05.00-01-N-G		

## 8 Revision history

**Table 8. Document revision history**

Date	Revision	Changes
19-Feb-2010	1	Initial release.
10-Mar-2010	2	<i>Figure 1</i> and <i>2</i> merged in <i>Figure 1</i>
26-Apr-2010	3	Modified: <i>Section 4.11: Touchscreen controller U1</i>



**Please Read Carefully:**

Information in this document is provided solely in connection with ST products. STMicroelectronics NV and its subsidiaries ("ST") reserve the right to make changes, corrections, modifications or improvements, to this document, and the products and services described herein at any time, without notice.

All ST products are sold pursuant to ST's terms and conditions of sale.

Purchasers are solely responsible for the choice, selection and use of the ST products and services described herein, and ST assumes no liability whatsoever relating to the choice, selection or use of the ST products and services described herein.

No license, express or implied, by estoppel or otherwise, to any intellectual property rights is granted under this document. If any part of this document refers to any third party products or services it shall not be deemed a license grant by ST for the use of such third party products or services, or any intellectual property contained therein or considered as a warranty covering the use in any manner whatsoever of such third party products or services or any intellectual property contained therein.

**UNLESS OTHERWISE SET FORTH IN ST'S TERMS AND CONDITIONS OF SALE ST DISCLAIMS ANY EXPRESS OR IMPLIED WARRANTY WITH RESPECT TO THE USE AND/OR SALE OF ST PRODUCTS INCLUDING WITHOUT LIMITATION IMPLIED WARRANTIES OF MERCHANTABILITY, FITNESS FOR A PARTICULAR PURPOSE (AND THEIR EQUIVALENTS UNDER THE LAWS OF ANY JURISDICTION), OR INFRINGEMENT OF ANY PATENT, COPYRIGHT OR OTHER INTELLECTUAL PROPERTY RIGHT.**

**UNLESS EXPRESSLY APPROVED IN WRITING BY AN AUTHORIZED ST REPRESENTATIVE, ST PRODUCTS ARE NOT RECOMMENDED, AUTHORIZED OR WARRANTED FOR USE IN MILITARY, AIR CRAFT, SPACE, LIFE SAVING, OR LIFE SUSTAINING APPLICATIONS, NOR IN PRODUCTS OR SYSTEMS WHERE FAILURE OR MALFUNCTION MAY RESULT IN PERSONAL INJURY, DEATH, OR SEVERE PROPERTY OR ENVIRONMENTAL DAMAGE. ST PRODUCTS WHICH ARE NOT SPECIFIED AS "AUTOMOTIVE GRADE" MAY ONLY BE USED IN AUTOMOTIVE APPLICATIONS AT USER'S OWN RISK.**

Resale of ST products with provisions different from the statements and/or technical features set forth in this document shall immediately void any warranty granted by ST for the ST product or service described herein and shall not create or extend in any manner whatsoever, any liability of ST.

ST and the ST logo are trademarks or registered trademarks of ST in various countries.

Information in this document supersedes and replaces all information previously supplied.

The ST logo is a registered trademark of STMicroelectronics. All other names are the property of their respective owners.

© 2010 STMicroelectronics - All rights reserved

STMicroelectronics group of companies

Australia - Belgium - Brazil - Canada - China - Czech Republic - Finland - France - Germany - Hong Kong - India - Israel - Italy - Japan - Malaysia - Malta - Morocco - Philippines - Singapore - Spain - Sweden - Switzerland - United Kingdom - United States of America

[www.st.com](http://www.st.com)