

CHIP COILS

for General Use Winding Type LQH31M/LQH32M/LQH43M(N) Series

LQH31M Series

■ Features

The chip inductor LQH31M series consists of miniature chip inductors wound on a special ferrite core. It have a high Q value at high frequencies and low DC resistance. Wide inductance range from 0.15 micro H to 100 micro H are available.

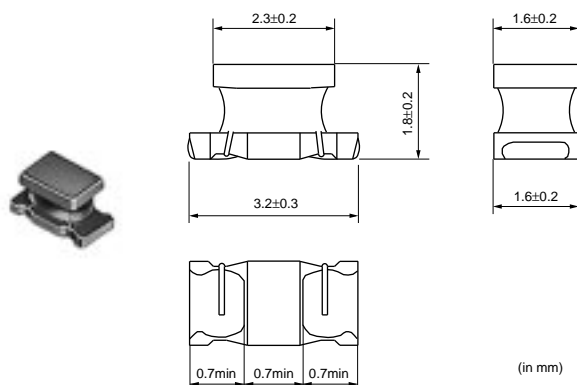

Part Number	Inductance (μH)	Rated Current (mA)	Max. of DC resistance (ohm)	Q (min.)	Self Resonance Frequency (MHz)
LQH31MN1R5J01	1.5 ±5%	155	1.3	35 at 10MHz	75 min.
LQH31MN1R8J01	1.8 ±5%	150	2.08	35 at 10MHz	60 min.
LQH31MN2R2J01	2.2 ±5%	140	0.91	35 at 10MHz	50 min.
LQH31MN2R7J01	2.7 ±5%	135	0.715	35 at 10MHz	43 min.
LQH31MN3R3J01	3.3 ±5%	130	1.82	35 at 8MHz	38 min.
LQH31MN3R9J01	3.9 ±5%	125	1.95	35 at 8MHz	35 min.
LQH31MN4R7J01	4.7 ±5%	120	2.21	35 at 8MHz	31 min.
LQH31MN5R6J01	5.6 ±5%	115	2.34	35 at 8MHz	28 min.
LQH31MN6R8J01	6.8 ±5%	110	2.6	35 at 8MHz	25 min.
LQH31MN8R2J01	8.2 ±5%	105	2.86	35 at 8MHz	23 min.
LQH31MN100J01	10 ±5%	100	3.25	35 at 5MHz	20 min.
LQH31MN120J01	12 ±5%	95	3.51	35 at 5MHz	18 min.
LQH31MN150J01	15 ±5%	90	3.9	35 at 5MHz	16 min.
LQH31MN180J01	18 ±5%	85	4.42	35 at 5MHz	15 min.
LQH31MN220J01	22 ±5%	85	4.03	40 at 2.5MHz	14 min.
LQH31MN270J01	27 ±5%	85	4.42	40 at 2.5MHz	13 min.
LQH31MN330J01	33 ±5%	80	4.94	40 at 2.5MHz	12 min.
LQH31MN390J01	39 ±5%	55	9.36	40 at 2.5MHz	11 min.
LQH31MN470J01	47 ±5%	55	10.4	40 at 2.5MHz	10 min.
LQH31MN560J01	56 ±5%	50	11.57	40 at 2.5MHz	9 min.
LQH31MN680J01	68 ±5%	50	12.87	40 at 2.5MHz	8.5 min.
LQH31MN820J01	82 ±5%	45	14.3	40 at 2.5MHz	7.5 min.
LQH31MN101J01	100 ±5%	45	15.6	40 at 2.5MHz	7 min.
LQH31MNR15K01	0.15 ±10%	250	0.546	20 at 25MHz	250 min.
LQH31MNR22K01	0.22 ±10%	240	0.602	20 at 25MHz	250 min.
LQH31MNR33K01	0.33 ±10%	230	0.63	30 at 25MHz	250 min.
LQH31MNR47K01	0.47 ±10%	215	1.162	30 at 25MHz	200 min.
LQH31MNR56K01	0.56 ±10%	200	0.854	30 at 25MHz	180 min.
LQH31MNR68K01	0.68 ±10%	190	0.938	30 at 25MHz	160 min.
LQH31MNR82K01	0.82 ±10%	185	1.022	30 at 25MHz	120 min.
LQH31MN1R0K01	1.0 ±10%	175	0.637	35 at 10MHz	100 min.
LQH31MN1R2K01	1.2 ±10%	165	1.17	35 at 10MHz	90 min.
LQH31MN1R5K01	1.5 ±10%	155	1.3	35 at 10MHz	75 min.
LQH31MN1R8K01	1.8 ±10%	150	2.08	35 at 10MHz	60 min.
LQH31MN2R2K01	2.2 ±10%	140	0.91	35 at 10MHz	50 min.
LQH31MN2R7K01	2.7 ±10%	135	0.715	35 at 10MHz	43 min.

Continued on the following page.

Continued from the preceding page.

Part Number	Inductance (μH)	Rated Current (mA)	Max. of DC resistance (ohm)	Q (min.)	Self Resonance Frequency (MHz)
LQH31MN3R3K01	3.3 ±10%	130	1.82	35 at 8MHz	38 min.
LQH31MN3R9K01	3.9 ±10%	125	1.95	35 at 8MHz	35 min.
LQH31MN4R7K01	4.7 ±10%	120	2.21	35 at 8MHz	31 min.
LQH31MN5R6K01	5.6 ±10%	115	2.34	35 at 8MHz	28 min.
LQH31MN6R8K01	6.8 ±10%	110	2.6	35 at 8MHz	25 min.
LQH31MN8R2K01	8.2 ±10%	105	2.86	35 at 8MHz	23 min.
LQH31MN100K01	10 ±10%	100	3.25	35 at 5MHz	20 min.
LQH31MN120K01	12 ±10%	95	3.51	35 at 5MHz	18 min.
LQH31MN150K01	15 ±10%	90	3.9	35 at 5MHz	16 min.
LQH31MN180K01	18 ±10%	85	4.42	35 at 5MHz	15 min.
LQH31MN220K01	22 ±10%	85	4.03	40 at 2.5MHz	14 min.
LQH31MN270K01	27 ±10%	85	4.42	40 at 2.5MHz	13 min.
LQH31MN330K01	33 ±10%	80	4.94	40 at 2.5MHz	12 min.
LQH31MN390K01	39 ±10%	55	9.36	40 at 2.5MHz	11 min.
LQH31MN470K01	47 ±10%	55	10.4	40 at 2.5MHz	10 min.
LQH31MN560K01	56 ±10%	50	11.57	40 at 2.5MHz	9 min.
LQH31MN680K01	68 ±10%	50	12.87	40 at 2.5MHz	8.5 min.
LQH31MN820K01	82 ±10%	45	14.3	40 at 2.5MHz	7.5 min.
LQH31MN101K01	100 ±10%	45	15.6	40 at 2.5MHz	7 min.

Min. of Operating Temp. : -25°C to 85°C

7

■ Q-Frequency Characteristics

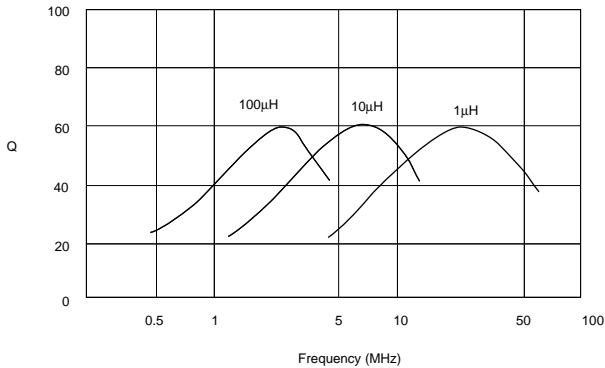

■ Inductance-Current Characteristics

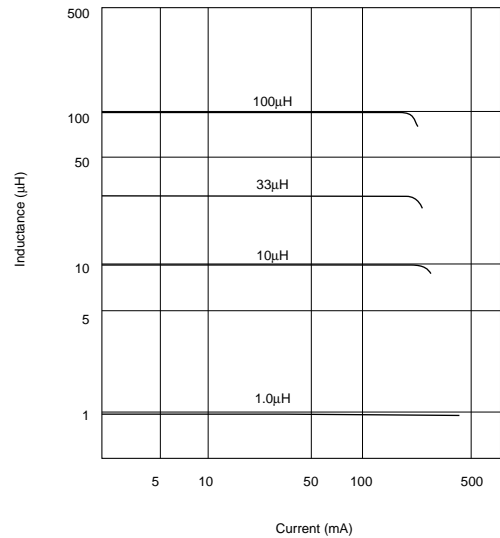

■ Coupling Coefficient

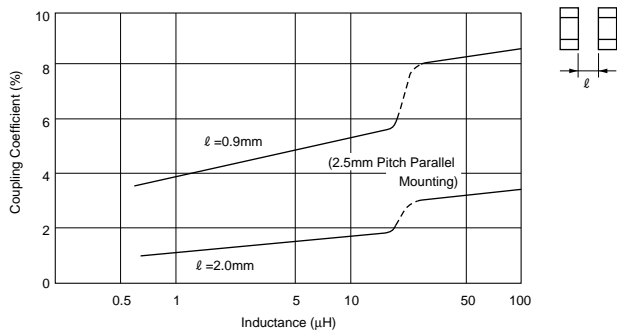

LQH32M Series

■ Features

The chip inductor LQH32M series consists of miniature chip inductors wound on a special ferrite core. It have a high Q value at high frequencies and low DC resistance. Wide inductance range from 0.10 micro H to 560 micro H are available.

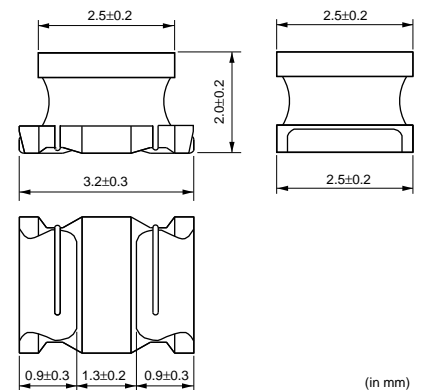

Part Number	Inductance (μH)	Rated Current (mA)	Max. of DC resistance (ohm)	Q (min.)	Self Resonance Frequency (MHz)
LQH32MN100J21	10 ±5%	190	1.8	35 at 1MHz	20 min.
LQH32MN120J21	12 ±5%	180	2	35 at 1MHz	18 min.
LQH32MN150J21	15 ±5%	170	2.2	35 at 1MHz	16 min.
LQH32MN180J21	18 ±5%	165	2.5	35 at 1MHz	15 min.
LQH32MN220J21	22 ±5%	150	2.8	35 at 1MHz	14 min.
LQH32MN270J21	27 ±5%	125	3.1	35 at 1MHz	13 min.
LQH32MN330J21	33 ±5%	115	3.5	40 at 1MHz	12 min.
LQH32MN390J21	39 ±5%	110	3.9	40 at 1MHz	11 min.
LQH32MN470J21	47 ±5%	100	4.3	40 at 1MHz	11 min.
LQH32MN560J21	56 ±5%	85	4.9	40 at 1MHz	10 min.
LQH32MN680J21	68 ±5%	80	5.5	40 at 1MHz	9 min.
LQH32MN820J21	82 ±5%	70	6.2	40 at 1MHz	8.5 min.
LQH32MN101J21	100 ±5%	80	7	40 at 0.796MHz	8 min.
LQH32MN121J21	120 ±5%	75	8	40 at 0.796MHz	7.5 min.
LQH32MN151J21	150 ±5%	70	9.3	40 at 0.796MHz	7 min.
LQH32MN181J21	180 ±5%	65	10.2	40 at 0.796MHz	6 min.
LQH32MN221J21	220 ±5%	65	11.8	40 at 0.796MHz	5.5 min.
LQH32MN271J21	270 ±5%	65	12.5	40 at 0.796MHz	5 min.
LQH32MN331J21	330 ±5%	65	13	40 at 0.796MHz	5 min.
LQH32MN391J21	390 ±5%	50	22	50 at 0.796MHz	5 min.
LQH32MN471J21	470 ±5%	45	25	50 at 0.796MHz	5 min.
LQH32MN561J21	560 ±5%	40	28	50 at 0.796MHz	5 min.
LQH32MN1R5K21	1.5 ±10%	400	0.6	20 at 1MHz	75 min.
LQH32MN1R8K21	1.8 ±10%	390	0.7	20 at 1MHz	60 min.
LQH32MN2R2K21	2.2 ±10%	370	0.8	20 at 1MHz	50 min.
LQH32MN2R7K21	2.7 ±10%	320	0.9	20 at 1MHz	43 min.
LQH32MN3R3K21	3.3 ±10%	300	1	20 at 1MHz	38 min.
LQH32MN3R9K21	3.9 ±10%	290	1.1	20 at 1MHz	35 min.
LQH32MN4R7K21	4.7 ±10%	270	1.2	20 at 1MHz	31 min.
LQH32MN5R6K21	5.6 ±10%	250	1.3	20 at 1MHz	28 min.
LQH32MN6R8K21	6.8 ±10%	240	1.5	20 at 1MHz	25 min.
LQH32MN8R2K21	8.2 ±10%	225	1.6	20 at 1MHz	23 min.
LQH32MN100K21	10 ±10%	190	1.8	35 at 1MHz	20 min.
LQH32MN120K21	12 ±10%	180	2	35 at 1MHz	18 min.
LQH32MN150K21	15 ±10%	170	2.2	35 at 1MHz	16 min.
LQH32MN180K21	18 ±10%	165	2.5	35 at 1MHz	15 min.
LQH32MN220K21	22 ±10%	150	2.8	35 at 1MHz	14 min.
LQH32MN270K21	27 ±10%	125	3.1	35 at 1MHz	13 min.
LQH32MN330K21	33 ±10%	115	3.5	40 at 1MHz	12 min.
LQH32MN390K21	39 ±10%	110	3.9	40 at 1MHz	11 min.
LQH32MN470K21	47 ±10%	100	4.3	40 at 1MHz	11 min.
LQH32MN560K21	56 ±10%	85	4.9	40 at 1MHz	10 min.

Continued on the following page.

Continued from the preceding page.

Part Number	Inductance (μH)	Rated Current (mA)	Max. of DC resistance (ohm)	Q (min.)	Self Resonance Frequency (MHz)
LQH32MN680K21	68 ±10%	80	5.5	40 at 1MHz	9 min.
LQH32MN820K21	82 ±10%	70	6.2	40 at 1MHz	8.5 min.
LQH32MN101K21	100 ±10%	80	7	40 at 0.796MHz	8 min.
LQH32MN121K21	120 ±10%	75	8	40 at 0.796MHz	7.5 min.
LQH32MN151K21	150 ±10%	70	9.3	40 at 0.796MHz	7 min.
LQH32MN181K21	180 ±10%	65	10.2	40 at 0.796MHz	6 min.
LQH32MN221K21	220 ±10%	65	11.8	40 at 0.796MHz	5.5 min.
LQH32MN271K21	270 ±10%	65	12.5	40 at 0.796MHz	5 min.
LQH32MN331K21	330 ±10%	65	13	40 at 0.796MHz	5 min.
LQH32MN391K21	390 ±10%	50	22	50 at 0.796MHz	5 min.
LQH32MN471K21	470 ±10%	45	25	50 at 0.796MHz	5 min.
LQH32MN561K21	560 ±10%	40	28	50 at 0.796MHz	5 min.
LQH32MNR10M21	0.1 ±20%	700	0.25	20 at 25.2MHz	200 min.
LQH32MNR18M21	0.18 ±20%	650	0.25	20 at 25.2MHz	200 min.
LQH32MNR27M21	0.27 ±20%	600	0.25	25 at 25.2MHz	200 min.
LQH32MNR39M21	0.39 ±20%	530	0.25	25 at 25.2MHz	200 min.
LQH32MNR56M21	0.56 ±20%	530	0.25	30 at 25.2MHz	160 min.
LQH32MNR68M21	0.68 ±20%	470	0.25	30 at 25.2MHz	160 min.
LQH32MNR82M21	0.82 ±20%	450	0.25	30 at 25.2MHz	120 min.
LQH32MN1R0M21	1 ±20%	445	0.5	20 at 1MHz	100 min.
LQH32MN1R2M21	1.2 ±20%	425	0.6	20 at 1MHz	100 min.

Min. of Operating Temp. : -25°C to 85°C

7

■ Q-Frequency Characteristics

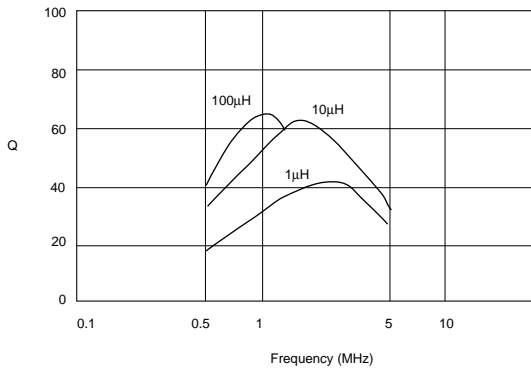

■ Inductance-Current Characteristics

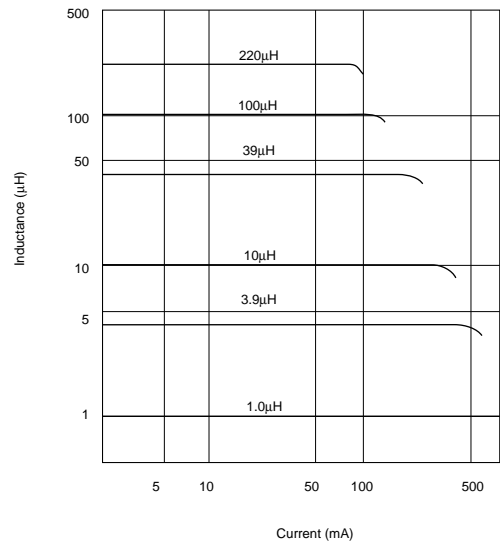

LQH43M/N Series

■ Features

The chip inductor LQH43M series consists of miniature chip inductors wound on a special ferrite core. It has a high Q value at high frequencies and low DC resistance. Wide inductance range from 1.0 micro H to 2200 micro H are available.

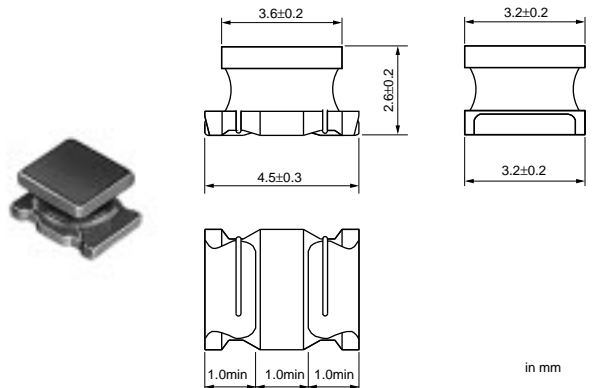

Part Number	Inductance (μH)	Rated Current (mA)	Max. of DC resistance (ohm)	Q (min.)	Self Resonance Frequency (MHz)
LQH43MN100J01	10 ±5%	400	0.56	35 at 1MHz	23 min.
LQH43MN120J01	12 ±5%	380	0.62	35 at 1MHz	21 min.
LQH43MN150J01	15 ±5%	360	0.73	35 at 1MHz	19 min.
LQH43MN180J01	18 ±5%	340	0.82	35 at 1MHz	17 min.
LQH43MN220J01	22 ±5%	320	0.94	35 at 1MHz	15 min.
LQH43MN270J01	27 ±5%	300	1.1	35 at 1MHz	14 min.
LQH43MN330J01	33 ±5%	270	1.2	35 at 1MHz	12 min.
LQH43MN390J01	39 ±5%	240	1.4	35 at 1MHz	11 min.
LQH43MN470J01	47 ±5%	220	1.5	35 at 1MHz	10 min.
LQH43MN560J01	56 ±5%	200	1.7	35 at 1MHz	9.3 min.
LQH43MN680J01	68 ±5%	180	1.9	35 at 1MHz	8.4 min.
LQH43MN820J01	82 ±5%	170	2.2	35 at 1MHz	7.5 min.
LQH43MN101J01	100 ±5%	160	2.5	40 at 0.796MHz	6.8 min.
LQH43MN121J01	120 ±5%	150	3	40 at 0.796MHz	6.2 min.
LQH43MN151J01	150 ±5%	130	3.7	40 at 0.796MHz	5.5 min.
LQH43MN181J01	180 ±5%	120	4.5	40 at 0.796MHz	5 min.
LQH43MN221J01	220 ±5%	110	5.4	40 at 0.796MHz	4.5 min.
LQH43MN271J01	270 ±5%	100	6.8	40 at 0.796MHz	4 min.
LQH43MN331J01	330 ±5%	95	8.2	40 at 0.796MHz	3.6 min.
LQH43MN391J01	390 ±5%	90	9.7	40 at 0.796MHz	3.3 min.
LQH43MN471J01	470 ±5%	80	11.8	40 at 0.796MHz	3 min.
LQH43MN561J01	560 ±5%	70	14.5	40 at 0.796MHz	2.7 min.
LQH43MN681J01	680 ±5%	65	17	40 at 0.796MHz	2.5 min.
LQH43MN821J01	820 ±5%	60	20.5	40 at 0.796MHz	2.2 min.
LQH43MN102J01	1000 ±5%	50	25	40 at 0.252MHz	2 min.
LQH43MN122J01	1200 ±5%	45	30	40 at 0.252MHz	1.8 min.
LQH43MN152J01	1500 ±5%	40	37	40 at 0.252MHz	1.6 min.
LQH43NN182J01	1800 ±5%	35	45	40 at 0.252MHz	1.5 min.
LQH43NN222J01	2200 ±5%	30	50	40 at 0.252MHz	1.3 min.
LQH43MN4R7K01	4.7 ±10%	500	0.4	30 at 1MHz	38 min.
LQH43MN5R6K01	5.6 ±10%	500	0.47	30 at 1MHz	33 min.
LQH43MN6R8K01	6.8 ±10%	450	0.5	30 at 1MHz	31 min.
LQH43MN8R2K01	8.2 ±10%	450	0.56	30 at 1MHz	27 min.
LQH43MN100K01	10 ±10%	400	0.56	35 at 1MHz	23 min.
LQH43MN120K01	12 ±10%	380	0.62	35 at 1MHz	21 min.
LQH43MN150K01	15 ±10%	360	0.73	35 at 1MHz	19 min.
LQH43MN180K01	18 ±10%	340	0.82	35 at 1MHz	17 min.
LQH43MN220K01	22 ±10%	320	0.94	35 at 1MHz	15 min.
LQH43MN270K01	27 ±10%	300	1.1	35 at 1MHz	14 min.
LQH43MN330K01	33 ±10%	270	1.2	35 at 1MHz	12 min.
LQH43MN390K01	39 ±10%	240	1.4	35 at 1MHz	11 min.
LQH43MN470K01	47 ±10%	220	1.5	35 at 1MHz	10 min.
LQH43MN560K01	56 ±10%	200	1.7	35 at 1MHz	9.3 min.
LQH43MN680K01	68 ±10%	180	1.9	35 at 1MHz	8.4 min.
LQH43MN820K01	82 ±10%	170	2.2	35 at 1MHz	7.5 min.
LQH43MN101K01	100 ±10%	160	2.5	40 at 0.796MHz	6.8 min.
LQH43MN121K01	120 ±10%	150	3	40 at 0.796MHz	6.2 min.
LQH43MN151K01	150 ±10%	130	3.7	40 at 0.796MHz	5.5 min.
LQH43MN181K01	180 ±10%	120	4.5	40 at 0.796MHz	5 min.
LQH43MN221K01	220 ±10%	110	5.4	40 at 0.796MHz	4.5 min.
LQH43MN271K01	270 ±10%	100	6.8	40 at 0.796MHz	4 min.
LQH43MN331K01	330 ±10%	95	8.2	40 at 0.796MHz	3.6 min.
LQH43MN391K01	390 ±10%	90	9.7	40 at 0.796MHz	3.3 min.
LQH43MN471K01	470 ±10%	80	11.8	40 at 0.796MHz	3 min.
LQH43MN561K01	560 ±10%	70	14.5	40 at 0.796MHz	2.7 min.
LQH43MN681K01	680 ±10%	65	17	40 at 0.796MHz	2.5 min.
LQH43MN821K01	820 ±10%	60	20.5	40 at 0.796MHz	2.2 min.

Continued on the following page. 

 Continued from the preceding page.

Part Number	Inductance (μH)	Rated Current (mA)	Max. of DC resistance (ohm)	Q (min.)	Self Resonance Frequency (MHz)
LQH43MN102K01	1000 ±10%	50	25	40 at 0.252MHz	2 min.
LQH43MN122K01	1200 ±10%	45	30	40 at 0.252MHz	1.8 min.
LQH43MN152K01	1500 ±10%	40	37	40 at 0.252MHz	1.6 min.
LQH43NN182K01	1800 ±10%	35	45	40 at 0.252MHz	1.5 min.
LQH43NN222K01	2200 ±10%	30	50	40 at 0.252MHz	1.3 min.
LQH43MN1R0M01	1 ±20%	500	0.2	20 at 1MHz	120 min.
LQH43MN1R2M01	1.2 ±20%	500	0.2	20 at 1MHz	100 min.
LQH43MN1R5M01	1.5 ±20%	500	0.3	20 at 1MHz	85 min.
LQH43MN1R8M01	1.8 ±20%	500	0.3	20 at 1MHz	75 min.
LQH43MN2R2M01	2.2 ±20%	500	0.3	20 at 1MHz	62 min.
LQH43MN2R7M01	2.7 ±20%	500	0.32	20 at 1MHz	53 min.
LQH43MN3R3M01	3.3 ±20%	500	0.35	20 at 1MHz	47 min.
LQH43MN3R9M01	3.9 ±20%	500	0.38	20 at 1MHz	41 min.

Min. of Operating Temp. : -25°C to 85°C

■ Q-Frequency Characteristics

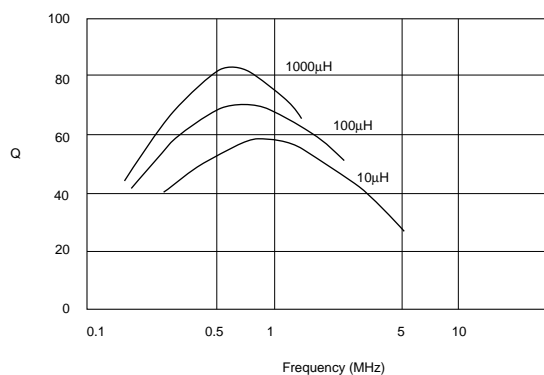

■ Inductance-Current Characteristics

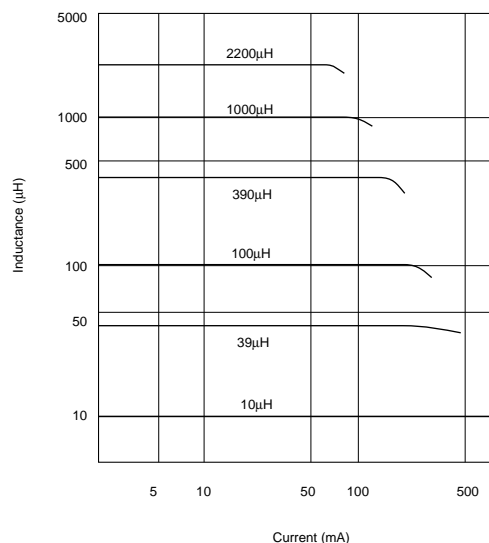

7

● **Part Numbering** (The structure of the "Global Part Numbers" that will be adopted from June 2001 and the meaning of each code are described herein.)
 (If you have any questions about details, inquire at your usual Murata sales office or distributor.)

Chip Coils (SMD)

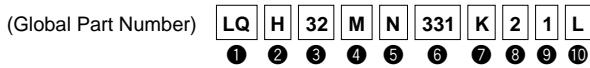

① Product ID

Product ID	
LQ	Chip Coils

② Structure

Code	Structure
G	Monolithic Type (Air-core Coil)
H	Winding Type (Ferrite Core)
M	Monolithic (Ferriet Core)
P	Film Type
W	Winding Type (Air-core Coil)

③ Dimension (L×W)

Code	Dimension (L×W)
03	0.60×0.30mm
15	1.00×0.50mm
18	1.60×0.80mm
21	2.00×1.25mm
2B	2.00×1.50mm
31	3.20×1.60mm
32	3.20×2.50mm
3E	3.50×3.20mm
3K	3.30×3.30mm
43	4.50×3.20mm
55	5.70×5.00mm
66	6.30×6.30mm

④ Applications and Characteristics

Code	Series	Applications and Characteristics
H	LQG	Monolithic Air-core
N		for Resonant Circuit
D	LQM	for Choke (Low-current DC Power Supplies)
F		for Choke (DC Power Supplies)
M	LQP	Film Type
T		Film Type (Low DC Resistance Type)
A	LQW	High Q Type (UFH-SHF)
H		High Q Type (VHF-UHF)
N		for Resonant Circuit
M		for Resonant Circuit (Coating Type)
R	LQH	for Resonant Circuit (Magnetically Shielded Type)
D		for Choke
C		for Choke (Coating Type)
S		for Choke (Magnetically Shielded Type)
H		for High-frequency Resonant Circuit

⑤ Category

Code	Category
N	Standard Type

⑥ Inductance

Expressed by three figures. The unit is micro-henry (μH). The first and second figures are significant digits, and the third figure expresses the number of zero which follow the two figures. If there is a decimal point, it is expressed by capital letter "R". In this case, all figures are significant digits. If inductance is less than 0.1μH, the inductance code is expressed by combination of two figures are capital letter "N", and the unit of inductance is nano-henry (nH). Capital letter "N" indicates the unit of "nH", and also expresses a decimal point. In this case, all figure are significant digits.

⑦ Inductance Tolerance

Code	Inductance Tolerance
B	±0.1nH
C	±0.2nH
D	±0.5nH
G	±2%
H	±3%
J	±5%
K	±10%
M	±20%
N	±30%
S	±0.3nH

⑧ Features

Expressed by a figure from "0" to "2".

Ex.)

Code	Features
0	Standard Type

⑨ Electrode

Code	Electrode
0	Solder Plating
1	Sputtering
2	Sn Plating

⑩ Packaging

Code	Pakaging
K	Plastic Taping (ø330mm Reel)
L	Plastic Taping (ø180mm Reel)
B	Bulk
J	Paper Taping (ø330mm Reel)
D	Paper Taping (ø180mm Reel)

Monolithic And Film Type Notice(Soldering and Mounting)

1. STANDARD LAND DIMENSIONS

A high Q value is achieved when the PCB electrode land pattern is designed so that it does not project beyond the chip coil electrode.

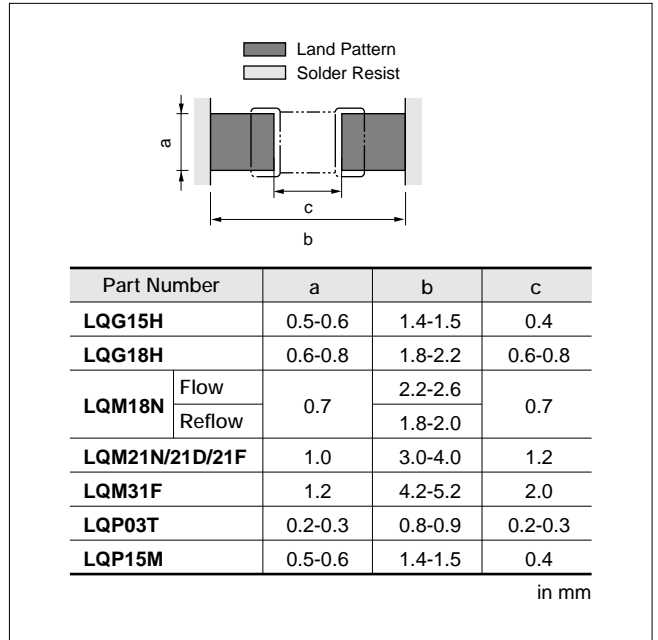

2. STANDARD SOLDERING CONDITIONS

1) Soldering method

Chip coils can be flow or reflow soldered. Please contact Murata regarding other soldering methods.

The volume of solder can cause minor fluctuations in inductance value. Therefore, carefully control the amount of solder when soldering the LQG15H/18H, LQP03T and LQP15M series.

2) Soldering Temperature and Time

Solder within the temperature and time combinations indicated by the slanted lines in the following graphs. If soldering is repeated, please note that the allowed time is the accumulated time.

Solder : Use H60A,H63A(JIS Z 3282) or equivalent.

Use solder paste equivalent to H60A for LQP03T/15M and LQG15H/18H.

Flux : Use rosin-based flux, but not strongly acidic flux. (with chlorine content exceeding 0.2wt%)
Do not use water-soluble flux.

Allowable Flow Soldering Temperature and Time



Allowable Reflow Soldering Temperature and Time

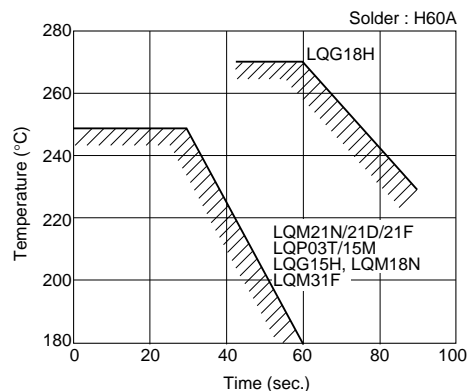

Continued on the following page.

Monolithic And Film Type Notice(Soldering and Mounting)

Continued from the preceding page.

3) Standard Soldering Conditions

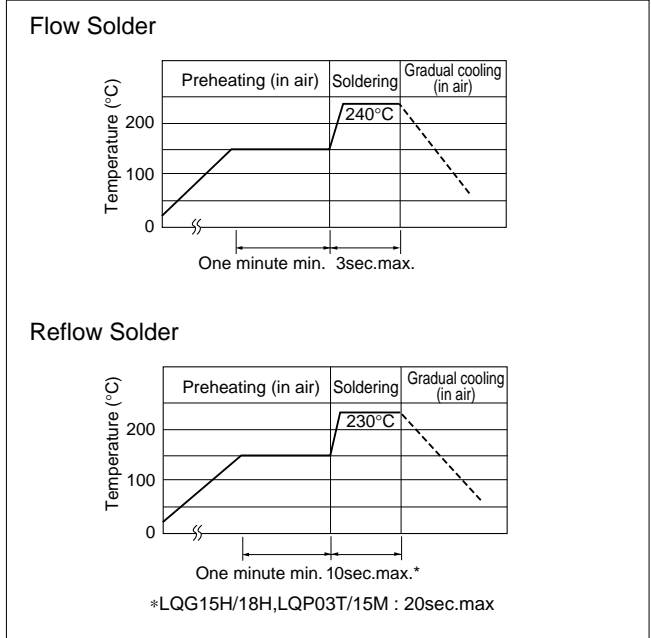

4) Reworking with Soldering Iron

Preheating at 150°C for 1 minute is required. Do not directly touch the ceramic element with the tip of the soldering iron. The reworking soldering conditions are as follows.

- Soldering iron power output : 30W Max.
- Temperature of soldering iron tip : 280°C
- Diameter of soldering iron end : 3.0mm Max.
- Soldering time : within 3 second

3. MOUNTING INSTRUCTIONS

1) Land Pattern Dimensions

Large lands reduce Q of the mounted chip. Also, large protruding land areas (bordered by lines having dimensions 'c' and 'd' shown below) cause floating and electrode cracks.

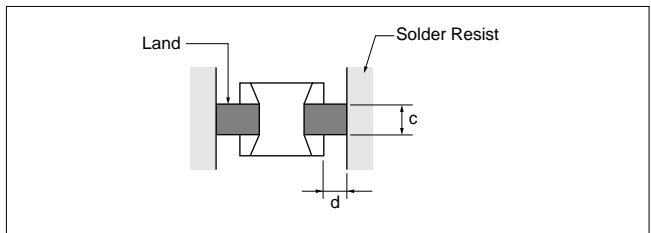

2) Magnetic Coupling

Since some chip coils are constructed like an open magnetic circuit, narrow spacing between coils may cause magnetic coupling. The LQG and LQM series have a magnetically shielded structure. The structure makes their coupling coefficient smaller than that of conventional chip coils.

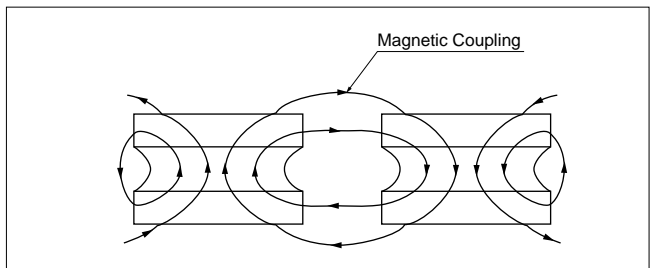

Continued on the following page.

Monolithic And Film Type Notice(Soldering and Mounting)

 Continued from the preceding page.

3) PCB Warping

Arrange chip coils to minimize stress caused by PCB warping.

The arrangement shown in Fig.2 is more effective in preventing stress than that shown in Fig.1.

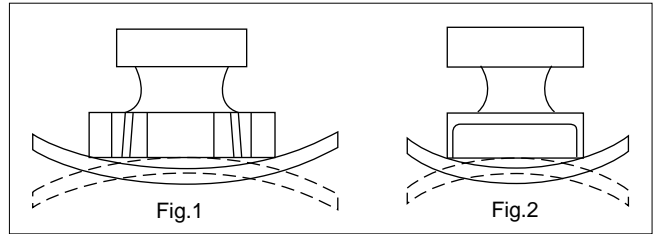

4) Amount of Solder Paste

Excessive solder causes electrode corrosion, while insufficient solder causes low electrode bonding strength. Adjust the amount of solder paste so that solder is applied as shown in the right.

Standard thickness of solder paste : 100 to 150µm

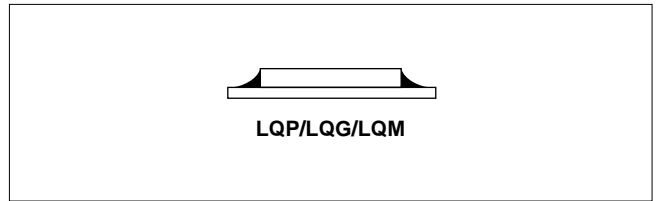

5) Amount of Adhesive

If too much adhesive is applied, then it may overflow into the land or termination areas and yield poor solderability. In contrast, if insufficient adhesive is applied, or if the adhesive is not sufficiently hardened, then the chip may become detached during flow soldering. Apply the adhesive in accordance with the following conditions.

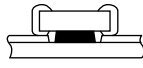

Part Number	Typical Application Amount (in:mg)		
	MR-8153RA	NF-3000	UVS-50R-2
LQM18N	0.05-0.06	0.06-0.07	0.06-0.07
LQM21N/21D/21F	0.15-0.20	0.20-0.25	0.20-0.25
LQM31F	0.20-0.25	0.25-0.30	0.25-0.30

Winding Type Notice(Soldering and Mounting)

1. STANDARD LAND DIMENSIONS

A high Q value is achieved when the PCB electrode land pattern is designed so that it does not project beyond the chip coil electrode.

Part Number	a	b	c	d
LQH31M/31C/31H	1.5	4.5	1.75	1.0
LQW31H				
LQW2BH	1.2	3.0	1.1	0.8
LQW18A	0.7-1.0	1.8-2.0	0.6-0.7	0.6-0.8
LQW15A	0.65	1.2	0.35	0.50

in mm

If mounted at 2.5 (2.0) mm intervals as indicated in the diagram, attention should be paid to potential magnetic coupling effects when using the coil as a resonator.

LQH43M
LQH43N
LQH43C

in mm

Continued on the following page.

Winding Type Notice(Soldering and Mounting)

Continued from the preceding page.

2. STANDARD SOLDERING CONDITIONS

1) Soldering method

Chip coils can be flow or reflow soldered.

Please contact Murata regarding other soldering methods.

Reflow soldering should be applied for LQW15A/18A.

2) Soldering Temperature and Time

Solder within the temperature and time combinations indicated by the slanted lines in the following graphs. If soldering is repeated, please note that the allowed time is the accumulated time.

Solder : Use H60A,H63A(JIS Z 3282) or equivalent.

Flux : Use rosin-based flux, but not strongly acidic flux.
(with chlorine content exceeding 0.2wt%)

Do not use water-soluble flux.

Allowable Flow Soldering Temperature and Time

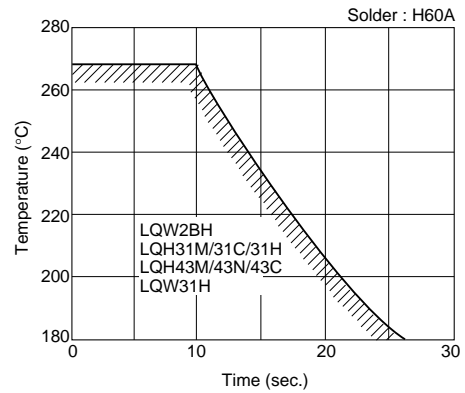

Allowable Reflow Soldering Temperature and Time

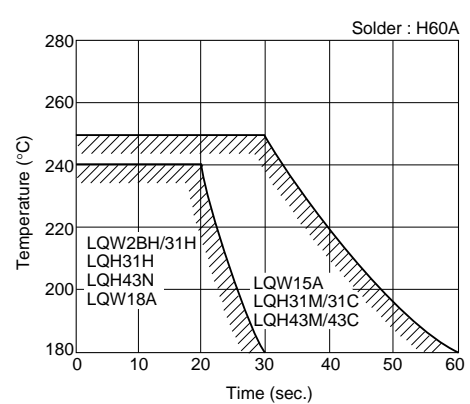

3) Standard Soldering Conditions

Flow Solder

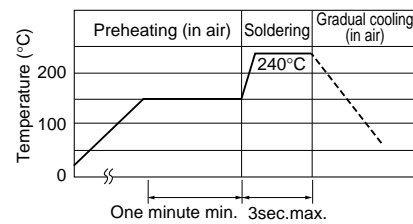

Reflow Solder

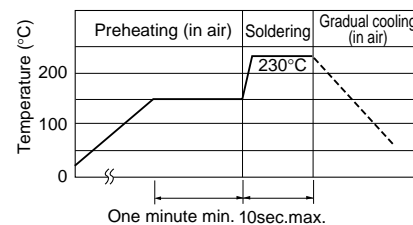

Continued on the following page.

Winding Type Notice(Soldering and Mounting)

 Continued from the preceding page.

4) Reworking with Soldering Iron

Preheating at 150°C for 1 minute is required. Do not directly touch the ceramic element with the tip of the soldering iron. The reworking soldering conditions are as follows.

- Soldering iron power output : 30W Max.
- Temperature of soldering iron tip : 280°C
- Diameter of soldering iron end : 3.0mm Max.
- Soldering time : within 3 second

3. MOUNTING INSTRUCTIONS

1) Land Pattern Dimensions

Large lands reduce Q of the mounted chip. Also, large protruding land areas (bordered by lines having dimensions 'c' and 'd' shown below) cause floating and electrode cracks.

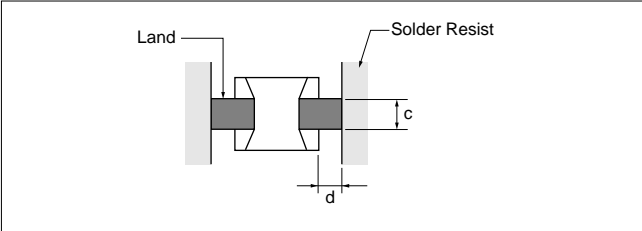

2) Magnetic Coupling

Since some chip coils are constructed like an open magnetic circuit, narrow spacing between coils may cause magnetic coupling. The LQH series have a magnetically shielded structure. The structure makes their coupling coefficient smaller than that of conventional chip coils.

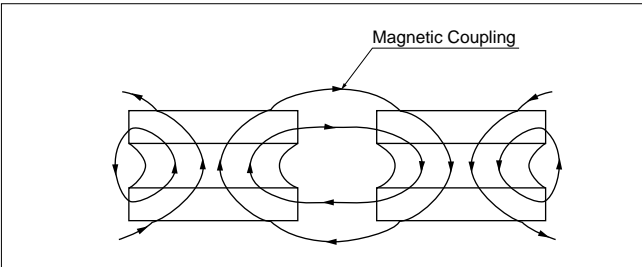

3) PCB Warping

Arrange chip coils to minimize stress caused by PCB warping. The arrangement shown in Fig.2 is more effective in preventing stress than that shown in Fig.1.

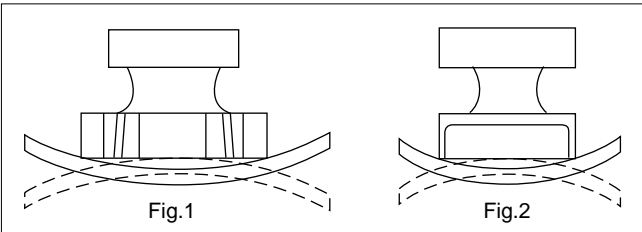

4) Amount of Solder Paste

Excessive solder causes electrode corrosion, while insufficient solder causes low electrode bonding strength. Adjust the amount of solder paste so that solder is applied as shown in the right. Standard thickness of solder paste: 200µm to 300µm (LQW15A/18A : 100 to 150µm)

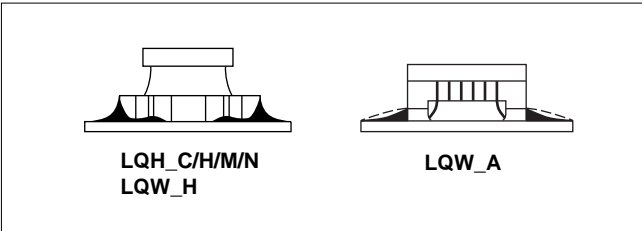

Continued on the following page. 

Winding Type Notice(Soldering and Mounting)

 Continued from the preceding page.

5) Amount of Adhesive

If too much adhesive is applied, then it may overflow into the land or termination areas and yield poor solderability. In contrast, if insufficient adhesive is applied, or if the adhesive is not sufficiently hardened, then the chip may become detached during flow soldering. Apply the adhesive in accordance with the following conditions.

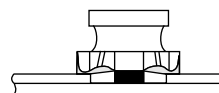

Part Number	Typical Application Amount (in:mg)		
	MR-8153RA	NF-3000	UVS-50R-2
LQW2BH	0.16-0.18	0.20-0.25	0.21-0.23
LQH31M/31C/31H LQW31H	0.18-0.20	0.20-0.25	0.20-0.25
LQH43M(N) LQH43C	0.45-0.50	0.60-0.80	0.60-0.80

Winding And Mgnetic Shielded Type Notice(Soldering and Mounting)

1. STANDARD LAND DIMENSIONS

A high Q value is achieved when the PCB electrode land pattern is designed so that it does not project beyond the chip coil electrode.

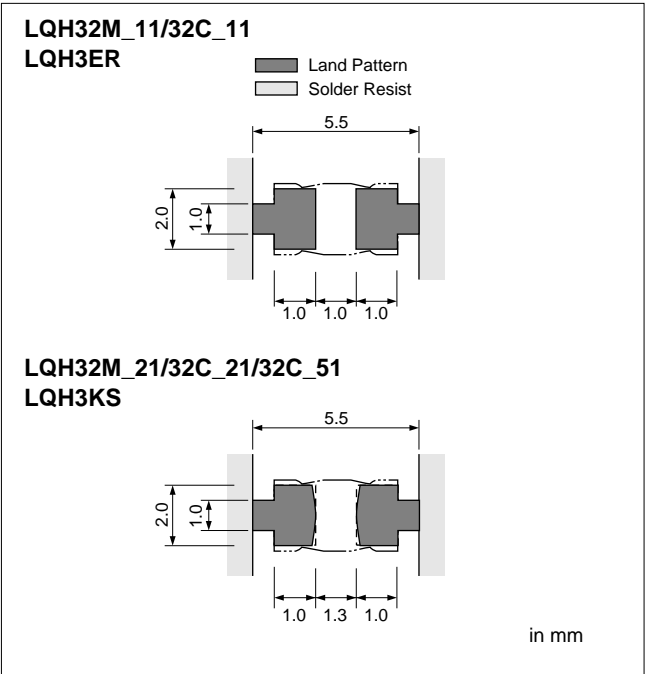

2. STANDARD SOLDERING CONDITIONS

1) Soldering method

Chip coils can be flow or reflow soldered.
Please contact Murata regarding other soldering methods.
Reflow soldering should be applied for LQH3ER/3KS.

2) Soldering Temperature and Time

Solder within the temperature and time combinations indicated by the slanted lines in the following graphs. If soldering is repeated, please note that the allowed time is the accumulated time.

- Solder : Use H60A,H63A(JIS Z 3282) or equivalent.
- Flux : Use rosin-based flux, but not strongly acidic flux.
(with chlorine content exceeding 0.2wt%)
Do not use water-soluble flux.

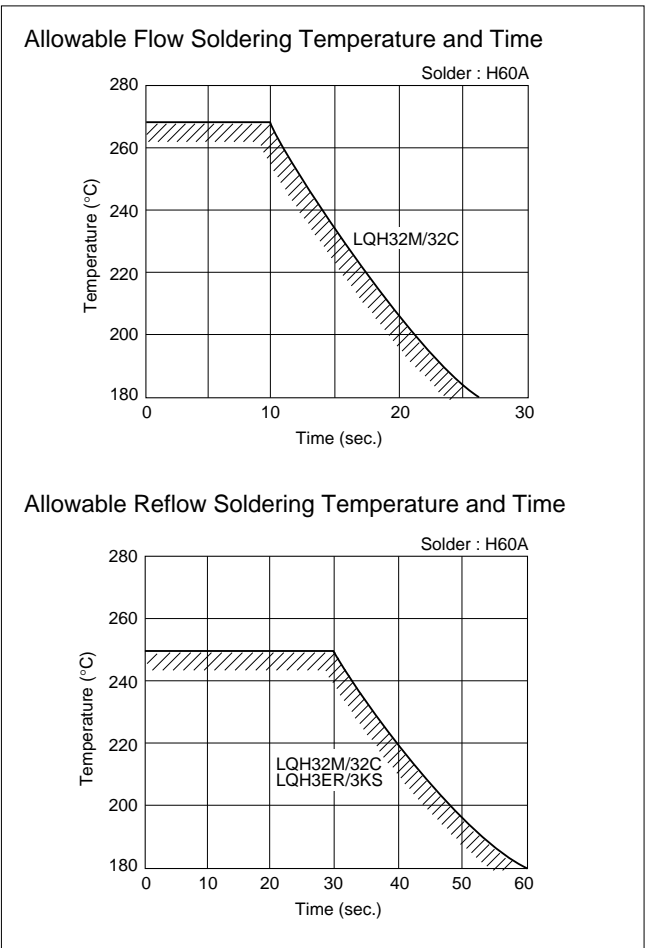

Continued on the following page.

Winding And Mgnetic Shielded Type Notice(Soldering and Mounting)

Continued from the preceding page.

3) Standard Soldering Conditions

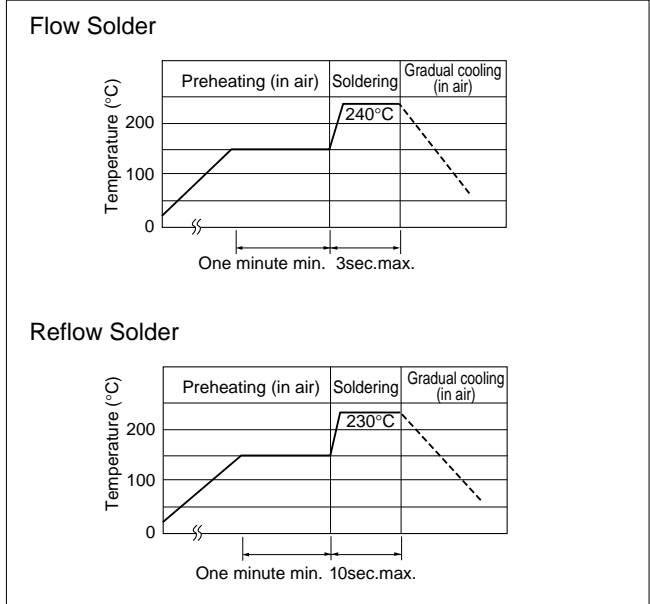

4) Reworking with Soldering Iron

Preheating at 150°C for 1 minute is required. Do not directry touch the ceramic element with the tip of the soldering iron. The reworking soldering conditions are as follows.

- Soldering iron power output : 30W Max.
- Temperature of soldering iron tip : 280°C
- Diameter of soldering iron end : 3.0mm Max.
- Soldering time : within 3 second

3. MOUNTING INSTRUCTIONS

1) Land Pattern Dimensions

Large lands reduce Q of the mounted chip. Also, large protruding land areas (bordered by lines having dimensions 'c' and 'd' shown bellow) cause floating and electrode cracks.

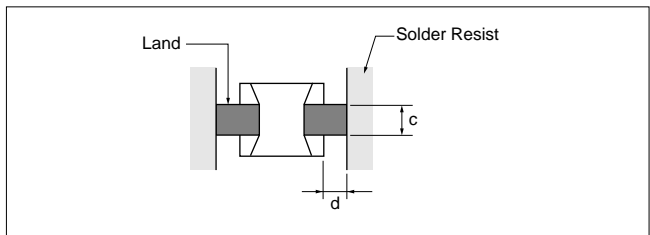

2) Magnetic Coupling

Since some chip coils are constructed like an open magnetic circuit, narrow spacing between coils may cause magnetic coupling. The LQH_R/S series have a magnetically shielded structure. The structure makes their coupling coefficient smaller than that of conventional chip coils. In particular, the LQH3ER series has a very small coupling coefficient.

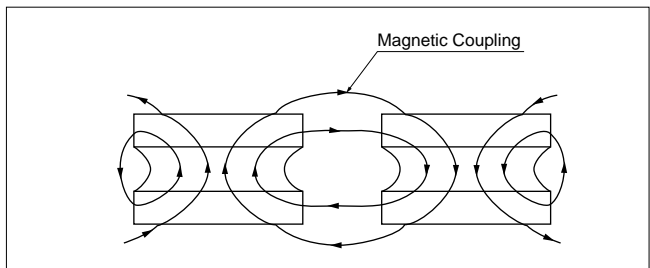

Continued on the following page.

Winding And Mgnetic Shielded Type Notice(Soldering and Mounting)

Continued from the preceding page.

3) PCB Warping

Arrange chip coils to minimize stress caused by PCB warping.

The arrangement shown in Fig.2 is more effective in preventing stress than that shown in Fig.1.

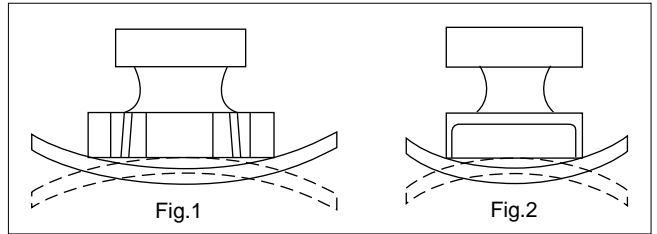

4) Amount of Solder Paste

Excessive solder causes electrode corrosion, while insufficient solder causes low electrode bonding strength. Adjust the amount of solder paste so that solder is applied as shown in the right.

Standard thickness of solder paste: 200µm to 300µm

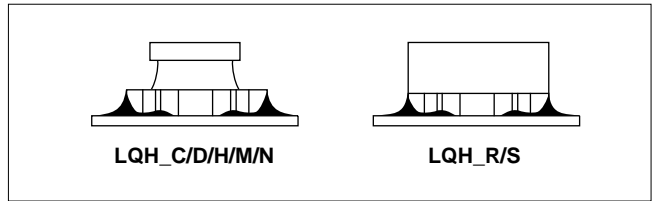

5) Amount of Adhesive

If too much adhesive is applied, then it may overflow into the land or termination areas and yield poor solderability. In contrast, if insufficient adhesive is applied, or if the adhesive is not sufficiently hardened, then the chip may become detached during flow soldering. Apply the adhesive in accordance with the following conditions.

Part Number	Typical Application Amount (in:mg)		
	MR-8153RA	NF-3000	UVS-50R-2
LQH32M/32C	0.20-0.23	0.27-0.35	0.27-0.35

Larege-current Type Notice(Soldering and Mounting)

1. STANDARD LAND DIMENSIONS

A high Q value is achieved when the PCB electrode land pattern is designed so that it does not project beyond the chip coil electrode.

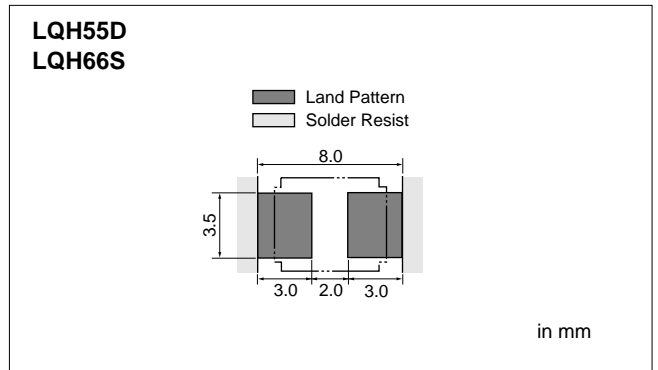

2. STANDARD SOLDERING CONDITIONS

1) Soldering method

Reflow soldering should be applied for LQH55D/66S.

2) Soldering Temperature and Time

Solder within the temperature and time combinations indicated by the slanted lines in the following graphs. If soldering is repeated, please note that the allowed time is the accumulated time.

Solder : Use H60A,H63A(JIS Z 3282) or equivalent.

Flux : Use rosin-based flux, but not strongly acidic flux.
 (with chlorine content exceeding 0.2wt%)
 Do not use water-soluble flux.

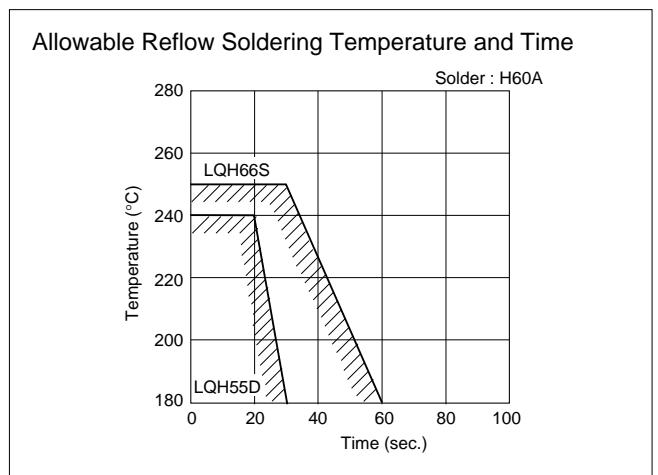

3) Standard Soldering Conditions

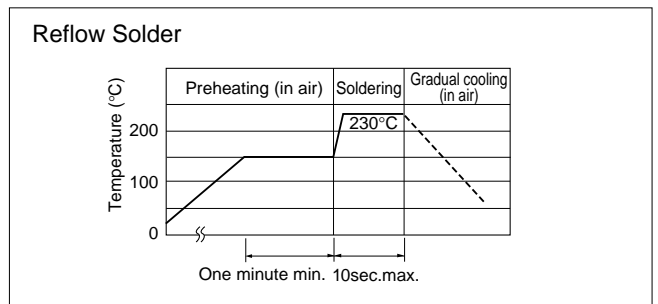

4) Reworking with Soldering Iron

Preheating at 150°C for 1 minute is required. Do not directly touch the ceramic element with the tip of the soldering iron. The reworking soldering conditions are as follows.

Soldering iron power output : 30W Max.
 Temperature of soldering iron tip : 280°C
 Diameter of soldering iron end : 3.0mm Max.
 Soldering time : within 3 second

Continued on the following page.

Large-current Type Notice(Soldering and Mounting)

 Continued from the preceding page.

3. MOUNTING INSTRUCTIONS

1) Land Pattern Dimensions

Large lands reduce Q of the mounted chip. Also, large protruding land areas (bordered by lines having dimensions 'c' and 'd' shown below) cause floating and electrode cracks.

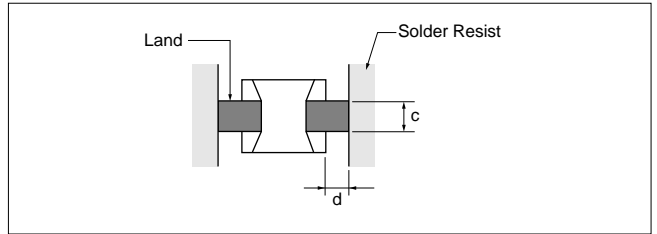

2) Magnetic Coupling

Since some chip coils are constructed like an open magnetic circuit, narrow spacing between coils may cause magnetic coupling. The LQH_S series have a magnetically shielded structure. The structure makes their coupling coefficient smaller than that of conventional chip coils.

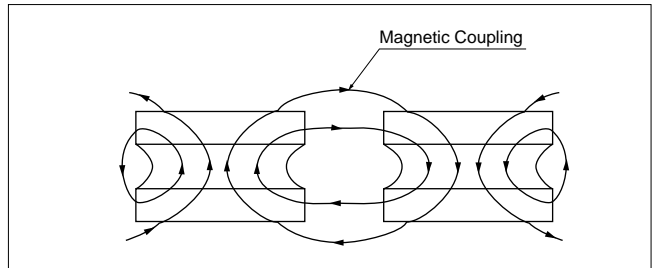

3) PCB Warping

Arrange chip coils to minimize stress caused by PCB warping. The arrangement shown in Fig.2 is more effective in preventing stress than that shown in Fig.1.

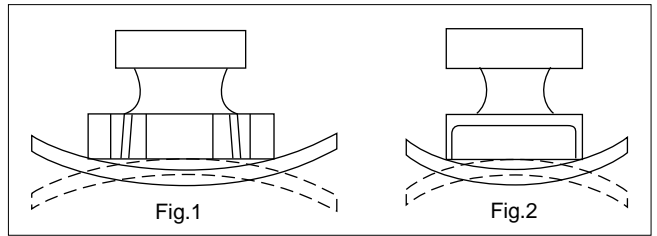

4) Amount of Solder Paste

Excessive solder causes electrode corrosion, while insufficient solder causes low electrode bonding strength. Adjust the amount of solder paste so that solder is applied as shown below. Standard thickness of solder paste: 200μm to 300μm

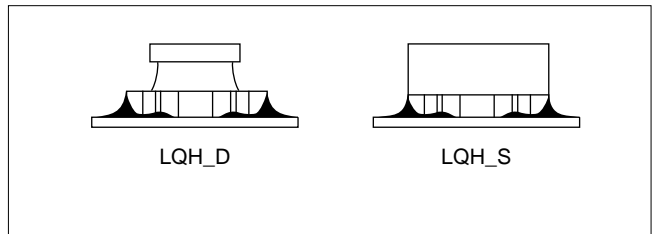

Notice

■ Notice (Storage and Operating Conditions)

< OPERATING ENVIRONMENT >

Do not use products in chemical atmosphere such as chlorine gas, acid or sulfide gas.

< STORAGE REQUIREMENTS >

1. Storage Period

Products should be used within 12 months reckon from the date of our out-going inspection.

Solderability should be verified if this period is exceeded. (LQH3ER/3KS series should be used within 6 months.)

2. Storage conditions

- a) Store products in a warehouse in compliance with the following conditions :
- Temperature : -10 to 40C.

Humidity : 30 to 70% (relative humidity)

Do not subject products to rapid changes in temperature and humidity.

Do not store them in chemical atmosphere such as one containing sulfurous acid gas or alkaline gas.

This will prevent electrode oxidation which causes poor solderability and possible corrosion of coils.

- b) Do not store products in bulk packaging to prevent collision among coils which causes core chipping and wire breakage.
- c) Store products on pallets to protect from humidity, dust, etc.
- d) Avoid heat shock, vibration, direct sunlight, etc.

■ Notice (Soldering and Mounting)

< CLEANING >

The following conditions should be observed when cleaning chip coils.

1. Cleaning Temperature : 60C. max. (40C. max. for CFC alternatives and alcohol cleaning agents)

2. Ultrasonic

Output : 20W/l max.

Duration : 5 minutes max.

Frequency : 28kHz to 40kHz

Care should be taken not to cause resonance of the PCB and mounted products.

3. Cleaning agent

The following cleaning agents have been tested on individual components. Evaluation in complete assembly should be done prior to production.

- a) CFC alternatives and alcohol cleaning agents
- Isopropyl alcohol (IPA)

- HCFC-225

b) Aqueous cleaning agents

- Surface active agent (Clean Thru 750H)
 - High grade alcohol (Pine Alpha ST-100S)
 - Hydrocarbon (Techno Cleaner 335)
 - Alkaline Saponifier (Aqua Cleaner 240 -cleaner should be diluted to 20% using deionized water.)
- LQH_R/S series : Aqueous agents should not be used because they may cause quality deterioration.
- LQH series : Surface active agent and high grade alcohol can be used.

4. Ensure that flux residue is completely removed.

Component should be thoroughly dried after aqueous agents have been removed with deionized water. For additional cleaning methods, please contact Murata.

■ Notice (Handling)

This item is designed to have sufficient strength, but handle with care not to make it chipped or broken due to its ceramic structure.

LQW_A series

- Sharp material, such as tweezers, shall not touch to the winding portion to prevent the breaking of wire.
- Do not give excessive Mechanical shock should not be applied to the products mounted on the board to prevent thebreaking of the core.
- In some mounting machines,when picking up components,support pin pushes up the components from the bottom of base tape. In this case,please remove the support pin. The support pin may damage the components and break wire.

LQH_C/D/H/M/N, LQW_H series

- Sharp material, such as tweezers, shall not touch to the winding portion to prevent the breaking of wire.
- Do not give excessive Mechanical shock should not be applied to the products mounted on the board to prevent thebreaking of the core.

LQP series

- The pattern of the chip coil is covered with the protection film. But the handling the chip coil shall be taken care so that the chip coil would not be damaged with the pick-up nozzle, the sharp

substance and so on.

LQM series

- There is possibility that the inductance value change due to magnetism. Do not use a magnet or tweezers with magnetism when chip coil are handled. (The tip of the tweezers should be molded with resin or pottery.)

< HANDLING >

1. Avoid applying excessive stress to products to prevent damage.
2. Do not touch winding with sharp objects such as tweezers to prevent wire breakage.
3. Do not apply excessive force to products mounted on boards to prevent core breakage.

< TRANSPORTATIONS >

Do not apply excessive vibration or mechanical shock to products.

< RESIN COATING >

When coating products with resin, the relatively high resin curing stress may change inductance values.

For exterior coating, select resin carefully so that electrical and mechanical performance of the product is not affected.

Packaging

Minimum Quantity and 8mm Width Taping Dimension

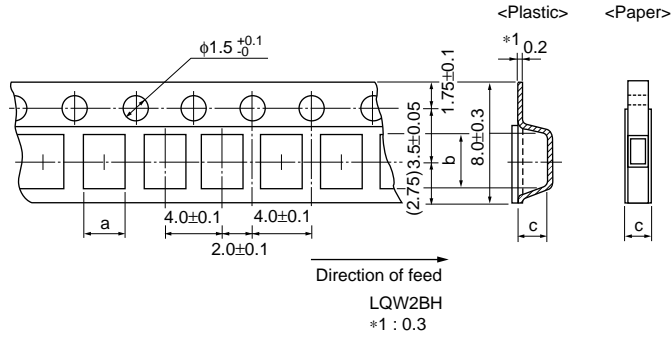

Paper Tape

Part Number	Dimensions (in mm)			Minimum QTY. (pcs.)		
	a	b	c	$\phi 180\text{mm}$ reel	$\phi 330\text{mm}$ reel	Bulk
LQM21NN (0.1-2.2 μH)	1.45	2.25	1.1	4000	10000	1000
LQM21DN (1-10 μH)						
LQM21FN (1-2.2 μH)						
LQG18H	1.05	1.85	1.0			
LQM18N			1.1			
LQW18A	1.00	1.80	0.95			-

Plastic Tape

Part Number	Dimensions (in mm)			Minimum QTY. (pcs.)			
	a	b	c	$\phi 180\text{mm}$ reel	$\phi 330\text{mm}$ reel	Bulk	
LQM21NN (2.7-4.7 μH)	1.45	2.25	1.3	4000	10000	1000	
LQM21DN (22-47 μH)							
LQM21FN (4.7-47 μH)							
LQM31F	1.9	3.5	1.3	3000			
LQH31M/31C/31H, LQW31H	1.9	3.6	2.0	2000			7500
LQW2BH	1.75	2.3					
LQH32M/LQH32C	2.9	3.6	2.1				
LQH32CN_51			1.7				

(in mm)

Continued on the following page.

Packaging

Continued from the preceding page.

Minimum Quantity and 8mm Width Taping Dimension

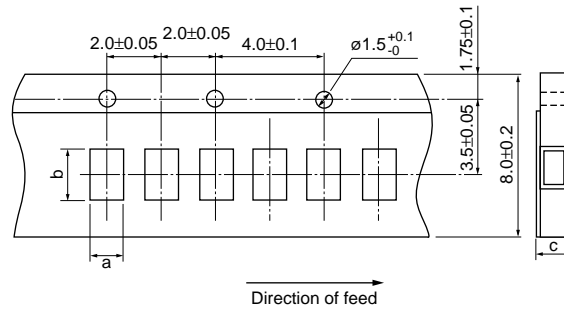

Paper Tape

Part Number	Dimensions (in mm)			Minimum QTY. (pcs.)		
	a	b	c	φ180mm reel	φ330mm reel	Bulk
LQG15H	0.62	1.12	1.0	10000	50000	1000
LQP03T	0.38	0.68				-
LQP15M	0.70	1.20	0.8		-	500
LQW15A						

(in mm)

Minimum Quantity and 12mm Width Plastic Taping Dimension

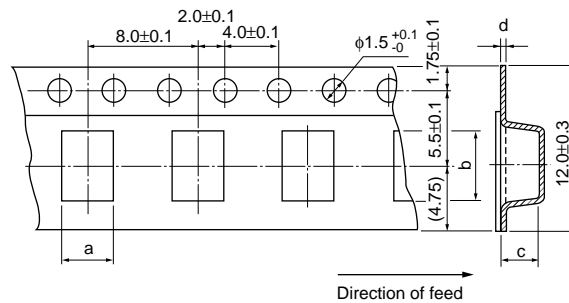

Part Number	Dimensions (in mm)				Minimum QTY. (pcs.)	
	a	b	c	d	φ180mm reel	φ330mm reel
LQH3ER, LQH3KS	3.9	3.7	1.9	0.3	1000	-
LQH43M(N)	3.6	4.9	2.7		500	2500
LQH43C						
LQH55D	5.4	6.1	5.0	0.4	350	1500
LQH66S	6.7	6.7	5.6			-

(in mm)

Design Kits



●EKLM12UB (High-frequency Winding Type)

No.	Part Number	Quantity (pcs.)	Inductance (nH)	Inductance Tolerance	Rated Current (mA)
1	LQW2BHN3N3D01	20	3.3	±0.5nH	910
2	LQW2BHN6N8D01	20	6.8	±0.5nH	680
3	LQW2BHN8N2D01	20	8.2	±0.5nH	630
4	LQW2BHN10NJ01	20	10	±5%	1320
5	LQW2BHN12NJ01	20	12	±5%	680
6	LQW2BHN15NJ01	20	15	±5%	630
7	LQW2BHN18NJ01	20	18	±5%	690
8	LQW2BHN22NJ01	20	22	±5%	720
9	LQW2BHN27NJ01	20	27	±5%	540
10	LQW2BHN33NJ01	20	33	±5%	570
11	LQW2BHN39NJ01	20	39	±5%	730
12	LQW2BHN47NJ01	20	47	±5%	450
13	LQW2BHN56NJ01	20	56	±5%	430
14	LQW2BHN68NJ01	20	68	±5%	460
15	LQW2BHN82NJ01	20	82	±5%	320
16	LQW2BHNR10J01	20	100	±5%	350
17	LQW2BHNR12J01	20	120	±5%	320
18	LQW2BHNR15J01	20	150	±5%	390
19	LQW2BHNR18J01	20	180	±5%	250
20	LQW2BHNR22J01	20	220	±5%	240
21	LQW2BHNR27K01	20	270	±10%	190
22	LQW2BHNR33K01	20	330	±10%	180
23	LQW2BHNR39K01	20	390	±10%	170
24	LQW2BHNR47K01	20	470	±10%	160
25	LQW2BHN2N7D11	20	2.7	±0.5nH	1900
26	LQW2BHN3N1D11	20	3.1	±0.5nH	1800
27	LQW2BHN3N3D11	20	3.3	±0.5nH	1700
28	LQW2BHN5N6D11	20	5.6	±0.5nH	1500
29	LQW2BHN6N8D11	20	6.8	±0.5nH	1400
30	LQW2BHN8N6D11	20	8.6	±0.5nH	1300
31	LQW2BHN10NJ11	20	10	±5%	1320
32	LQW2BHN12NK11	20	12	±10%	1100
33	LQW2BHN15NK11	20	15	±10%	1000
34	LQW2BHN18NK11	20	18.8	±10%	1000
35	LQW2BHN21NK11	20	21	±10%	950
36	LQW2BHN27NK11	20	27	±10%	900

Design Kits

●EKLM13UB (High-frequency Monolithic Type)

No.	Part Number	Quantity (pcs.)	Inductance (nH)	Inductance Tolerance	Rated Current (mA)
1	LQG18HN1N2S00	20	1.2	±0.3nH	300
2	LQG18HN1N5S00	20	1.5	±0.3nH	300
3	LQG18HN1N8S00	20	1.8	±0.3nH	300
4	LQG18HN2N2S00	20	2.2	±0.3nH	300
5	LQG18HN2N7S00	20	2.7	±0.3nH	300
6	LQG18HN3N3S00	20	3.3	±0.3nH	300
7	LQG18HN3N9S00	20	3.9	±0.3nH	300
8	LQG18HN4N7S00	20	4.7	±0.3nH	300
9	LQG18HN5N6S00	20	5.6	±0.3nH	300
10	LQG18HN6N8J00	20	6.8	±5%	300
11	LQG18HN8N2J00	20	8.2	±5%	300
12	LQG18HN10NJ00	20	10	±5%	300
13	LQG18HN12NJ00	20	12	±5%	300
14	LQG18HN15NJ00	20	15	±5%	300
15	LQG18HN18NJ00	20	18	±5%	300
16	LQG18HN22NJ00	20	22	±5%	300
17	LQG18HN27NJ00	20	27	±5%	300
18	LQG18HN33NJ00	20	33	±5%	300
19	LQG18HN39NJ00	20	39	±5%	300
20	LQG18HN47NJ00	20	47	±5%	300
21	LQG18HN56NJ00	20	56	±5%	300
22	LQG18HN68NJ00	20	68	±5%	300
23	LQG18HN82NJ00	20	82	±5%	300
24	LQG18HNR10J00	20	100	±5%	300

●EKLM14UC (High-frequency Flim Type)

No.	Part Number	Quantity (pcs.)	Inductance (nH)	Inductance Tolerance	Rated Current (mA)
1	LQP15MN1N0B00	20	1.0	±0.1nH	400
2	LQP15MN1N1B00	20	1.1	±0.1nH	390
3	LQP15MN1N2B00	20	1.2	±0.1nH	390
4	LQP15MN1N3B00	20	1.3	±0.1nH	280
5	LQP15MN1N5B00	20	1.5	±0.1nH	280
6	LQP15MN1N6B00	20	1.6	±0.1nH	220
7	LQP15MN1N8B00	20	1.8	±0.1nH	280
8	LQP15MN2N0B00	20	2.0	±0.1nH	220
9	LQP15MN2N2B00	20	2.2	±0.1nH	220
10	LQP15MN2N4B00	20	2.4	±0.1nH	220
11	LQP15MN2N7B00	20	2.7	±0.1nH	220
12	LQP15MN3N0B00	20	3.0	±0.1nH	190
13	LQP15MN3N3B00	20	3.3	±0.1nH	190
14	LQP15MN3N6B00	20	3.6	±0.1nH	170
15	LQP15MN3N9B00	20	3.9	±0.1nH	170
16	LQP15MN4N3B00	20	4.3	±0.1nH	160
17	LQP15MN4N7B00	20	4.7	±0.1nH	160
18	LQP15MN5N1B00	20	5.1	±0.1nH	140
19	LQP15MN5N6B00	20	5.6	±0.1nH	140
20	LQP15MN6N2B00	20	6.2	±0.1nH	130
21	LQP15MN6N8B00	20	6.8	±0.1nH	130
22	LQP15MN7N5B00	20	7.5	±0.1nH	110
23	LQP15MN8N2B00	20	8.2	±0.1nH	110
24	LQP15MN9N1B00	20	9.1	±0.1nH	100

Continued on the following page. 

Design Kits

 Continued from the preceding page.

No.	Part Number	Quantity (pcs.)	Inductance (nH)	Inductance Tolerance	Rated Current (mA)
25	LQP15MN10NG00	20	10	±2%	100
26	LQP15MN12NG00	20	12	±2%	90
27	LQP15MN15NG00	20	15	±2%	90
28	LQP15MN18NG00	20	18	±2%	80
29	LQP15MN22NG00	20	22	±2%	70
30	LQP15MN27NG00	20	27	±2%	70
31	LQP15MN33NG00	20	33	±2%	60

●EKLM15UB (High-frequency Monolithic Type)

No.	Part Number	Quantity (pcs.)	Inductance (nH)	Inductance Tolerance	Rated Current (mA)
1	LQG15HN1N2S00	20	1.2	±0.3nH	200
2	LQG15HN1N5S00	20	1.5	±0.3nH	200
3	LQG15HN1N8S00	20	1.8	±0.3nH	200
4	LQG15HN2N2S00	20	2.2	±0.3nH	200
5	LQG15HN2N7S00	20	2.7	±0.3nH	200
6	LQG15HN3N3S00	20	3.3	±0.3nH	200
7	LQG15HN3N9S00	20	3.9	±0.3nH	200
8	LQG15HN4N7S00	20	4.7	±0.3nH	200
9	LQG15HN5N6S00	20	5.6	±0.3nH	200
10	LQG15HN6N8J00	20	6.8	±5%	200
11	LQG15HN8N2J00	20	8.2	±5%	200
12	LQG15HN10NJ00	20	10	±5%	200
13	LQG15HN12NJ00	20	12	±5%	200
14	LQG15HN15NJ00	20	15	±5%	200
15	LQG15HN18NJ00	20	18	±5%	200
16	LQG15HN22NJ00	20	22	±5%	200
17	LQG15HN27NJ00	20	27	±5%	200
18	LQG15HN33NJ00	20	33	±5%	200

●EKLM16UB (High-frequency Winding Type)

No.	Part Number	Quantity (pcs.)	Inductance (nH)	Inductance Tolerance	Rated Current (mA)
1	LQW18AN3N6C00	20	3.6	±0.2nH	850
2	LQW18AN3N9C00	20	3.9	±0.2nH	850
3	LQW18AN4N3C00	20	4.3	±0.2nH	850
4	LQW18AN5N6C00	20	5.6	±0.2nH	750
5	LQW18AN6N2C00	20	6.2	±0.2nH	750
6	LQW18AN6N8C00	20	6.8	±0.2nH	750
7	LQW18AN10NG00	20	10	±2%	650
8	LQW18AN11NG00	20	11	±2%	650
9	LQW18AN12NG00	20	12	±2%	600
10	LQW18AN13NG00	20	13	±2%	600
11	LQW18AN15NG00	20	15	±2%	600
12	LQW18AN16NG00	20	16	±2%	550
13	LQW18AN18NG00	20	18	±2%	550
14	LQW18AN20NG00	20	20	±2%	550
15	LQW18AN22NG00	20	22	±2%	500
16	LQW18AN24NG00	20	24	±2%	500
17	LQW18AN27NG00	20	27	±2%	440
18	LQW18AN30NG00	20	30	±2%	420
19	LQW18AN33NG00	20	33	±2%	420
20	LQW18AN36NG00	20	36	±2%	400

Continued on the following page. 

Design Kits

 Continued from the preceding page.

No.	Part Number	Quantity (pcs.)	Inductance (nH)	Inductance Tolerance	Rated Current (mA)
21	LQW18AN39NG00	20	39	±2%	400
22	LQW18AN43NG00	20	43	±2%	380
23	LQW18AN47NG00	20	47	±2%	380
24	LQW18AN51NG00	20	51	±2%	370
25	LQW18AN56NG00	20	56	±2%	360
26	LQW18AN62NG00	20	62	±2%	280
27	LQW18AN68NG00	20	68	±2%	340
28	LQW18AN72NG00	20	72	±2%	270
29	LQW18AN75NG00	20	75	±2%	270
30	LQW18AN82NG00	20	82	±2%	250
31	LQW18AN91NG00	20	91	±2%	230
32	LQW18ANR10G00	20	100	±2%	220
33	LQW18ANR11G00	20	110	±2%	200
34	LQW18ANR12G00	20	120	±2%	180
35	LQW18ANR13G00	20	130	±2%	170
36	LQW18ANR15G00	20	150	±2%	160
37	LQW18ANR16G00	20	160	±2%	150
38	LQW18ANR18G00	20	180	±2%	140
39	LQW18ANR20G00	20	200	±2%	120
40	LQW18ANR22G00	20	220	±2%	120

●EKLM17UB (High-frequency Winding Type)

No.	Part Number	Quantity (pcs.)	Inductance (nH)	Inductance Tolerance	Rated Current (mA)
1	LQW18AN2N2D00	20	2.2	±0.5nH	700
2	LQW18AN3N6D00	20	3.6	±0.5nH	850
3	LQW18AN3N9D00	20	3.9	±0.5nH	850
4	LQW18AN4N3D00	20	4.3	±0.5nH	850
5	LQW18AN4N7D00	20	4.7	±0.5nH	850
6	LQW18AN5N6D00	20	5.6	±0.5nH	750
7	LQW18AN6N2D00	20	6.2	±0.5nH	750
8	LQW18AN6N8D00	20	6.8	±0.5nH	750
9	LQW18AN7N5D00	20	7.5	±0.5nH	750
10	LQW18AN8N2D00	20	8.2	±0.5nH	650
11	LQW18AN8N7D00	20	8.7	±0.5nH	650
12	LQW18AN9N1D00	20	9.1	±0.5nH	650
13	LQW18AN9N5D00	20	9.5	±0.5nH	650
14	LQW18AN10NJ00	20	10	±5%	650
15	LQW18AN11NJ00	20	11	±5%	650
16	LQW18AN12NJ00	20	12	±5%	600
17	LQW18AN13NJ00	20	13	±5%	600
18	LQW18AN15NJ00	20	15	±5%	600
19	LQW18AN16NJ00	20	16	±5%	550
20	LQW18AN18NJ00	20	18	±5%	550
21	LQW18AN20NJ00	20	20	±5%	550
22	LQW18AN22NJ00	20	22	±5%	500
23	LQW18AN24NJ00	20	24	±5%	500
24	LQW18AN27NJ00	20	27	±5%	440
25	LQW18AN30NJ00	20	30	±5%	420
26	LQW18AN33NJ00	20	33	±5%	420
27	LQW18AN36NJ00	20	36	±5%	400
28	LQW18AN39NJ00	20	39	±5%	400
29	LQW18AN43NJ00	20	43	±5%	380
30	LQW18AN47NJ00	20	47	±5%	380

Continued on the following page. 

Design Kits

 Continued from the preceding page.

No.	Part Number	Quantity (pcs.)	Inductance (nH)	Inductance Tolerance	Rated Current (mA)
31	LQW18AN51NJ00	20	51	±5%	370
32	LQW18AN56NJ00	20	56	±5%	360
33	LQW18AN62NJ00	20	62	±5%	280
34	LQW18AN68NJ00	20	68	±5%	340
35	LQW18AN72NJ00	20	72	±5%	270
36	LQW18AN75NJ00	20	75	±5%	270
37	LQW18AN82NJ00	20	82	±5%	250
38	LQW18AN91NJ00	20	91	±5%	230
39	LQW18ANR10J00	20	100	±5%	220
40	LQW18ANR11J00	20	110	±5%	200
41	LQW18ANR12J00	20	120	±5%	180
42	LQW18ANR13J00	20	130	±5%	170
43	LQW18ANR15J00	20	150	±5%	160
44	LQW18ANR16J00	20	160	±5%	150
45	LQW18ANR18J00	20	180	±5%	140
46	LQW18ANR20J00	20	200	±5%	120
47	LQW18ANR22J00	20	220	±5%	120

●EKL21UB (for General Use/ for Choke Monolithic Type)

No.	Part Number	Quantity (pcs.)	Inductance (nH)	Inductance Tolerance (%)	Rated Current (mA)
1	LQM21NNR10K10	20	0.1	±10	250
2	LQM21NNR12K10	20	0.12	±10	250
3	LQM21NNR15K10	20	0.15	±10	250
4	LQM21NNR18K10	20	0.18	±10	250
5	LQM21NNR22K10	20	0.22	±10	250
6	LQM21NNR27K10	20	0.27	±10	250
7	LQM21NNR33K10	20	0.33	±10	250
8	LQM21NNR39K10	20	0.39	±10	200
9	LQM21NNR47K10	20	0.47	±10	200
10	LQM21NNR56K10	20	0.56	±10	150
11	LQM21NNR68K10	20	0.68	±10	150
12	LQM21NNR82K10	20	0.82	±10	150
13	LQM21NN1R0K10	20	1.0	±10	50
14	LQM21NN1R2K10	20	1.2	±10	50
15	LQM21NN1R5K10	20	1.5	±10	50
16	LQM21NN1R8K10	20	1.8	±10	50
17	LQM21NN2R2K10	20	2.2	±10	30
18	LQM21NN2R7K10	20	2.7	±10	30
19	LQM21NN3R3K10	20	3.3	±10	30
20	LQM21NN3R9K10	20	3.9	±10	30
21	LQM21NN4R7K10	20	4.7	±10	30
22	LQM21DN1R0N00	20	1.0	±30	60
23	LQM21DN2R2N00	20	2.2	±30	40
24	LQM21DN4R7N00	20	4.7	±30	30
25	LQM21DN100N00	20	10	±30	15
26	LQM21DN220N00	20	22	±30	13
27	LQM21DN470N00	20	47	±30	7
28	LQM21FN1R0N00	20	1.0	±30	220
29	LQM21FN2R2N00	20	2.2	±30	150
30	LQM21FN4R7N00	20	4.7	±30	80
31	LQM21FN100N00	20	10	±30	60
32	LQM21FN220N00	20	22	±30	13
33	LQM21FN470N00	20	47	±30	7

Information

1. Land Area and Q-F Characteristics

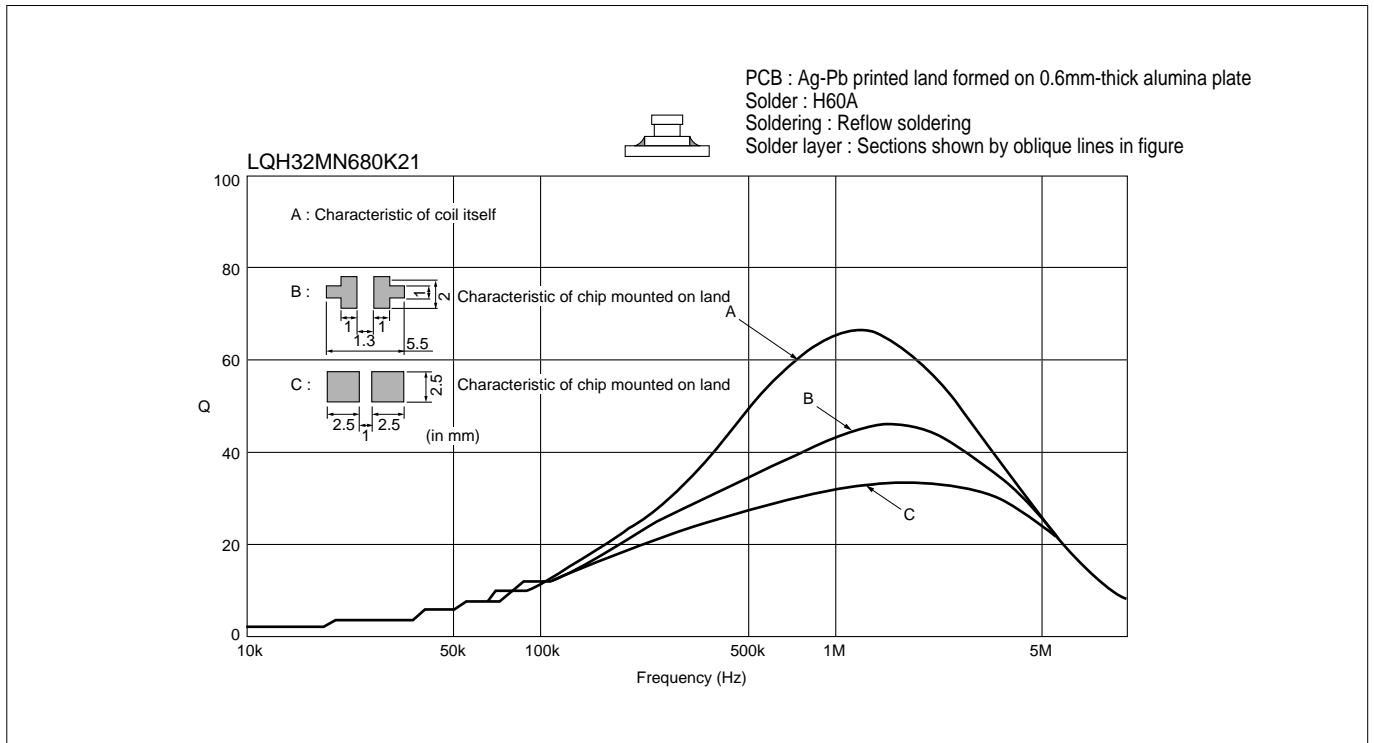

2. Coupling coefficient versus Coil-to-coil Spacing

