

BC817-16L, SBC817-16L, BC817-25L, SBC817-25L, BC817-40L, SBC817-40L

General Purpose Transistors

NPN Silicon

Features

- S and NSV Prefixes for Automotive and Other Applications Requiring Unique Site and Control Change Requirements; AEC-Q101 Qualified and PPAP Capable
- These Devices are Pb-Free, Halogen Free/BFR Free and are RoHS Compliant

MAXIMUM RATINGS

Rating	Symbol	Value	Unit
Collector – Emitter Voltage	V_{CEO}	45	V
Collector – Base Voltage	V_{CBO}	50	V
Emitter – Base Voltage	V_{EBO}	5.0	V
Collector Current – Continuous	I_C	500	mAdc

THERMAL CHARACTERISTICS

Characteristic	Symbol	Max	Unit
Total Device Dissipation FR-5 Board, (Note 1) $T_A = 25^\circ\text{C}$ Derate above 25°C	P_D	225 1.8	mW mW/ $^\circ\text{C}$
Thermal Resistance, Junction-to-Ambient	$R_{\theta JA}$	556	$^\circ\text{C}/\text{W}$
Total Device Dissipation Alumina Substrate, (Note 2) $T_A = 25^\circ\text{C}$ Derate above 25°C	P_D	300 2.4	mW mW/ $^\circ\text{C}$
Thermal Resistance, Junction-to-Ambient	$R_{\theta JA}$	417	$^\circ\text{C}/\text{W}$
Junction and Storage Temperature	T_J, T_{stg}	-65 to +150	$^\circ\text{C}$

Stresses exceeding those listed in the Maximum Ratings table may damage the device. If any of these limits are exceeded, device functionality should not be assumed, damage may occur and reliability may be affected.

1. FR-5 = 1.0 x 0.75 x 0.062 in.
2. Alumina = 0.4 x 0.3 x 0.024 in 99.5% alumina.



ON Semiconductor®

www.onsemi.com

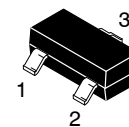
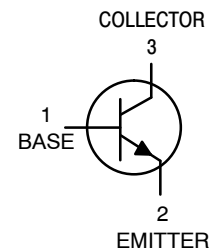

SOT-23
CASE 318
STYLE 6

MARKING DIAGRAM

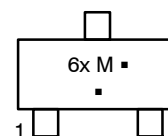

- 6x = Device Code
x = A, B, or C
- M = Date Code*
- = Pb-Free Package

(Note: Microdot may be in either location)

*Date Code orientation and/or overbar may vary depending upon manufacturing location.

ORDERING INFORMATION

See detailed ordering and shipping information in the package dimensions section on page 2 of this data sheet.

BC817-16L, SBC817-16L, BC817-25L, SBC817-25L, BC817-40L, SBC817-40L

ELECTRICAL CHARACTERISTICS (T_A = 25°C unless otherwise noted)

Characteristic	Symbol	Min	Typ	Max	Unit
OFF CHARACTERISTICS					
Collector - Emitter Breakdown Voltage (I _C = 10 mA)	V _{(BR)CEO}	45	-	-	V
Collector - Emitter Breakdown Voltage (V _{EB} = 0, I _C = 10 μA)	V _{(BR)CES}	50	-	-	V
Emitter - Base Breakdown Voltage (I _E = 1.0 μA)	V _{(BR)EBO}	5.0	-	-	V
Collector Cutoff Current (V _{CB} = 20 V) (V _{CB} = 20 V, T _A = 150°C)	I _{CBO}	-	-	100 5.0	nA μA

ON CHARACTERISTICS

DC Current Gain (I _C = 100 mA, V _{CE} = 1.0 V)	BC817-16, SBC817-16 BC817-25, SBC817-25 BC817-40, SBC817-40	h _{FE}	100	-	250	-
(I _C = 500 mA, V _{CE} = 1.0 V)			160	-	400	-
			250	-	600	-
			40	-	-	-
Collector - Emitter Saturation Voltage (I _C = 500 mA, I _B = 50 mA)	V _{CE(sat)}	-	-	0.7	V	
Base - Emitter On Voltage (I _C = 500 mA, V _{CE} = 1.0 V)	V _{BE(on)}	-	-	1.2	V	

SMALL-SIGNAL CHARACTERISTICS

Current - Gain - Bandwidth Product (I _C = 10 mA, V _{CE} = 5.0 Vdc, f = 100 MHz)	f _T	100	-	-	MHz
Output Capacitance (V _{CB} = 10 V, f = 1.0 MHz)	C _{obo}	-	10	-	pF

Product parametric performance is indicated in the Electrical Characteristics for the listed test conditions, unless otherwise noted. Product performance may not be indicated by the Electrical Characteristics if operated under different conditions.

ORDERING INFORMATION

Device	Specific Marking	Package	Shipping [†]
BC817-16LT1G	6A	SOT-23 (Pb-Free)	3000 / Tape & Reel
NSVBC817-16LT1G			10,000 / Tape & Reel
BC817-16LT3G			
SBC817-16LT3G			
BC817-25LT1G	6B	SOT-23 (Pb-Free)	3000 / Tape & Reel
SBC817-25LT1G			10,000 / Tape & Reel
BC817-25LT3G			
SBC817-25LT3G			
BC817-40LT1G	6C	SOT-23 (Pb-Free)	3000 / Tape & Reel
SBC817-40LT1G			10,000 / Tape & Reel
BC817-40LT3G			
SBC817-40LT3G			

[†]For information on tape and reel specifications, including part orientation and tape sizes, please refer to our Tape and Reel Packaging Specifications Brochure, BRD8011/D.

TYPICAL CHARACTERISTICS - BC817-16L, SBC817-16L

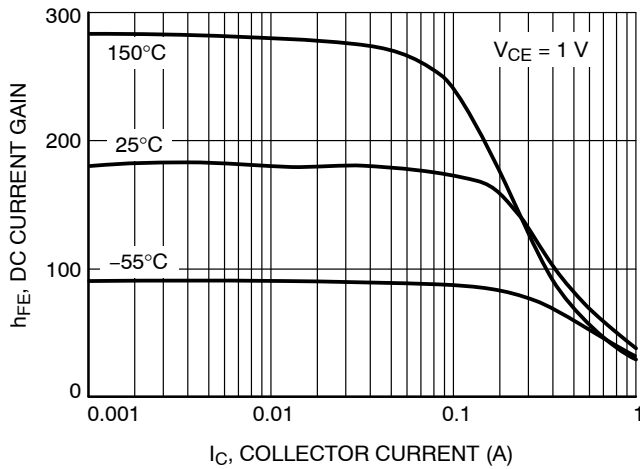

Figure 1. DC Current Gain vs. Collector Current

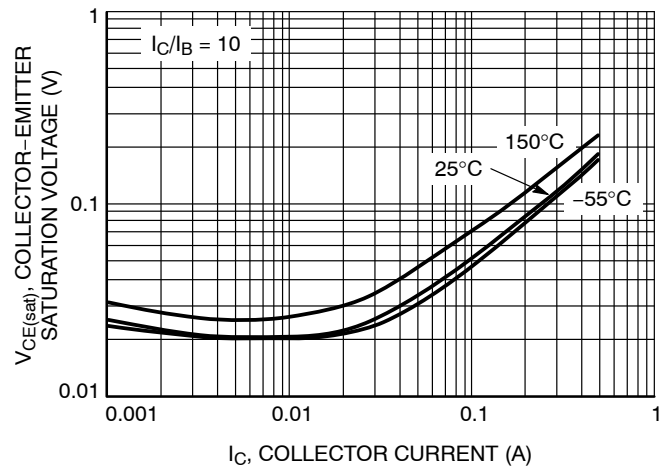

Figure 2. Collector Emitter Saturation Voltage vs. Collector Current

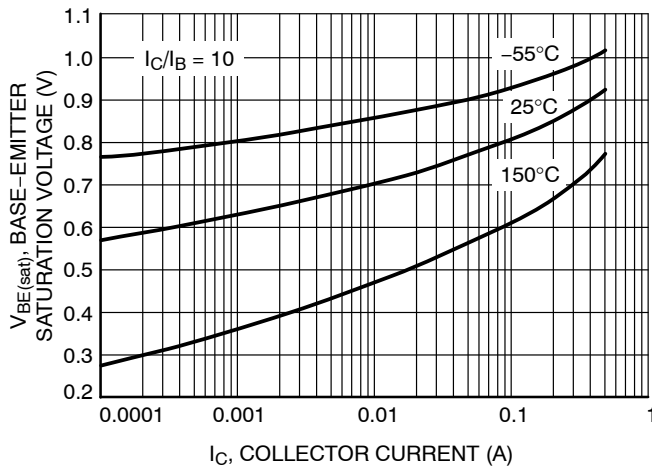

Figure 3. Base Emitter Saturation Voltage vs. Collector Current

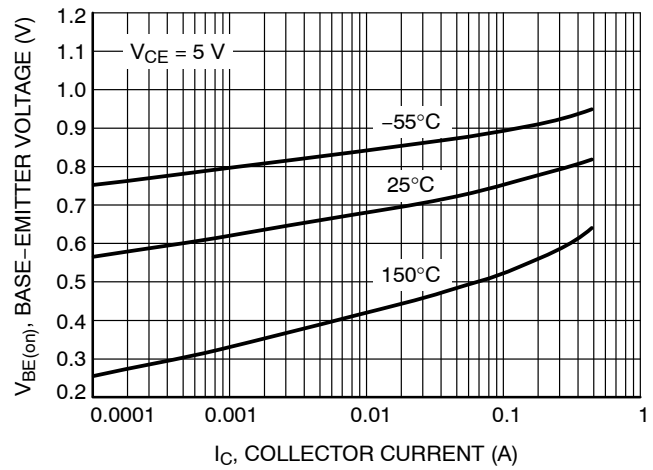

Figure 4. Base Emitter Voltage vs. Collector Current

TYPICAL CHARACTERISTICS - BC817-16L, SBC817-16L



Figure 5. Saturation Region



Figure 6. Temperature Coefficients

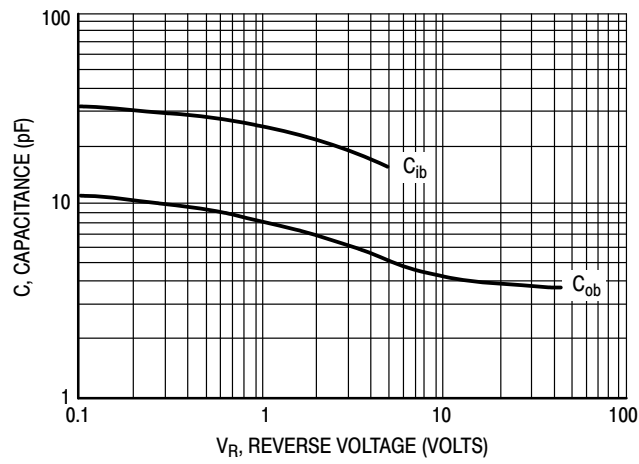

Figure 7. Capacitances

TYPICAL CHARACTERISTICS - BC817-25L, SBC817-25L

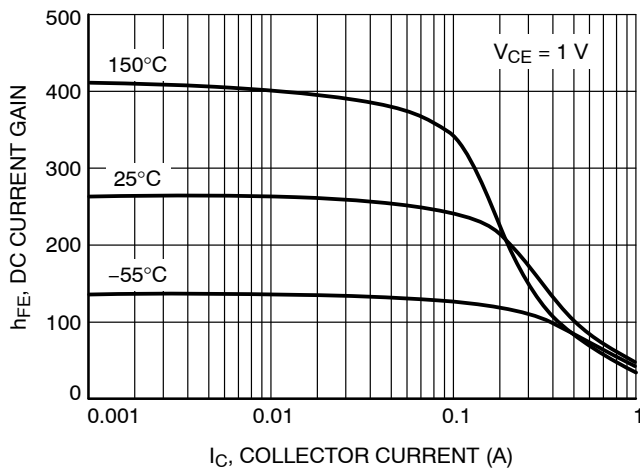

Figure 8. DC Current Gain vs. Collector Current

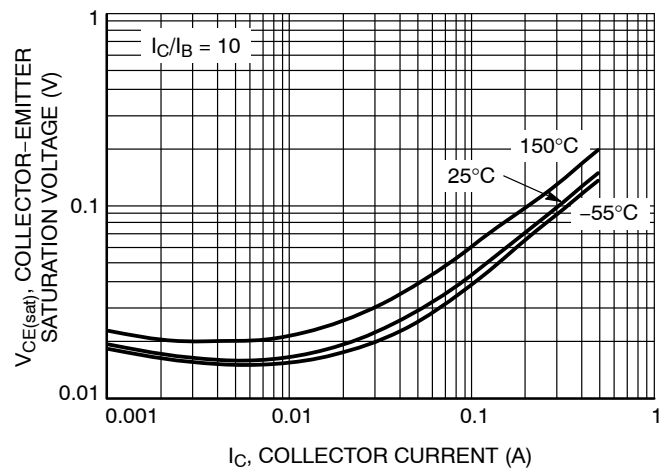

Figure 9. Collector Emitter Saturation Voltage vs. Collector Current



Figure 10. Base Emitter Saturation Voltage vs. Collector Current



Figure 11. Base Emitter Voltage vs. Collector Current

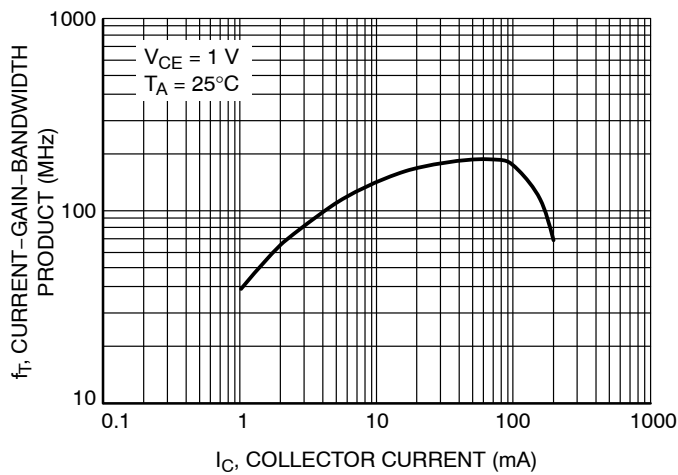

Figure 12. Current Gain Bandwidth Product vs. Collector Current

TYPICAL CHARACTERISTICS - BC817-25L, SBC81725L

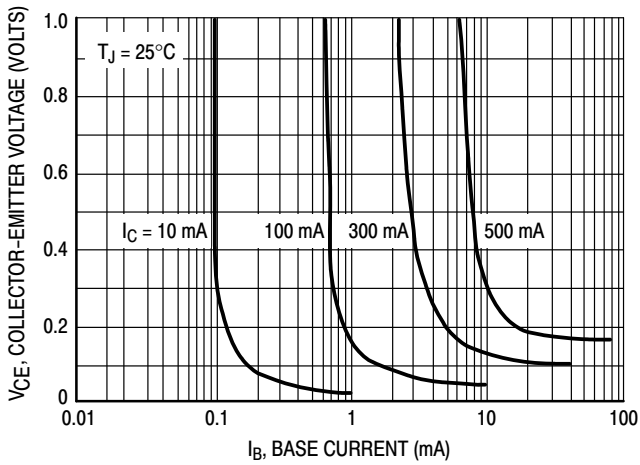

Figure 13. Saturation Region

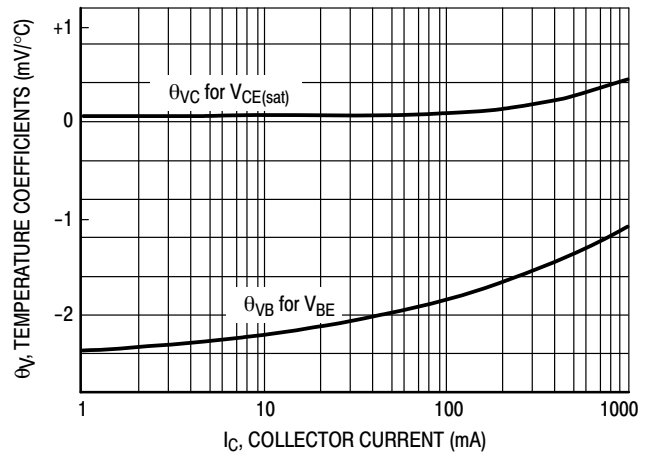

Figure 14. Temperature Coefficients

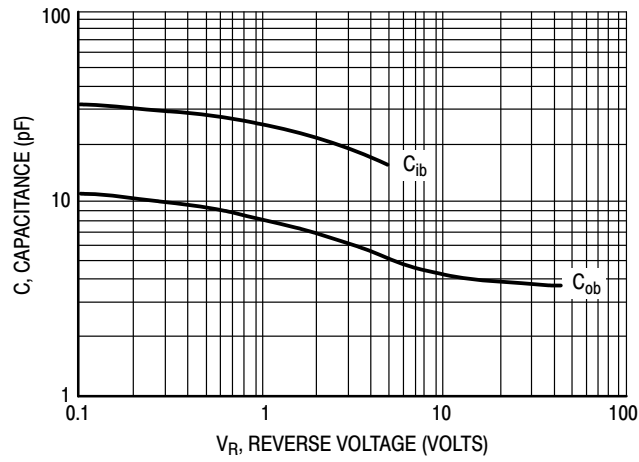

Figure 15. Capacitances

TYPICAL CHARACTERISTICS - BC817-40L, SBC817-40L



Figure 16. DC Current Gain vs. Collector Current

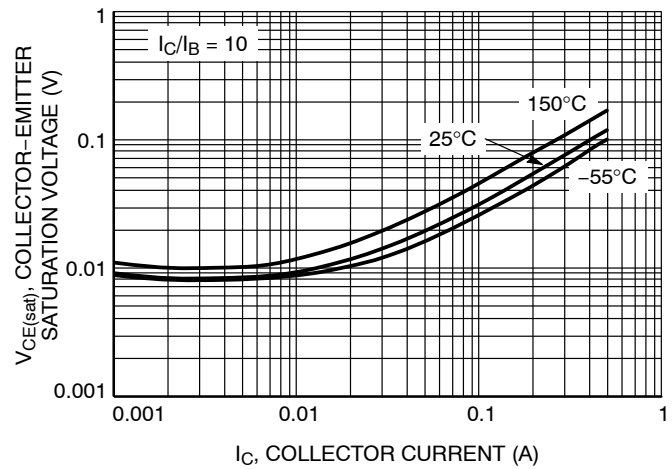

Figure 17. Collector Emitter Saturation Voltage vs. Collector Current



Figure 18. Base Emitter Saturation Voltage vs. Collector Current

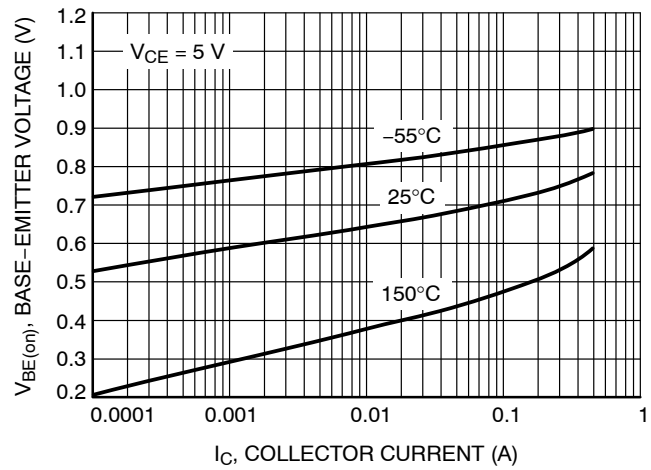

Figure 19. Base Emitter Voltage vs. Collector Current

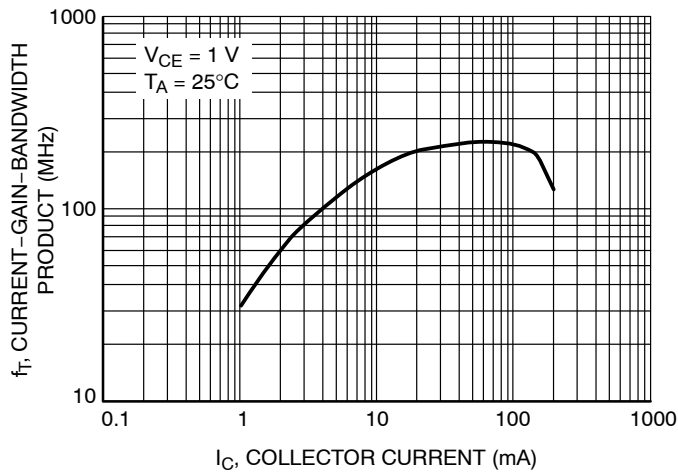

Figure 20. Current Gain Bandwidth Product vs. Collector Current

TYPICAL CHARACTERISTICS - BC817-40L, SBC817-40L

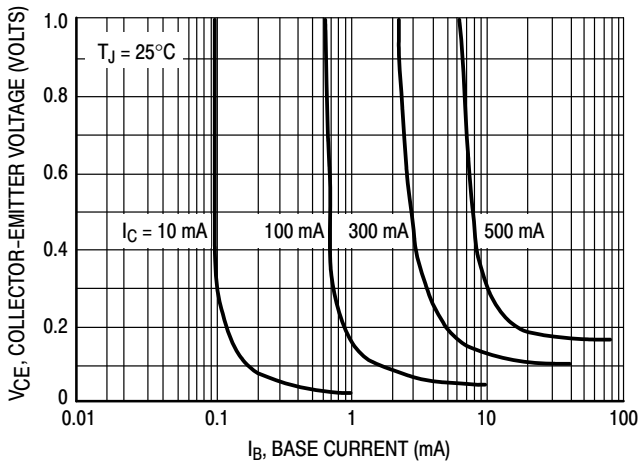

Figure 21. Saturation Region

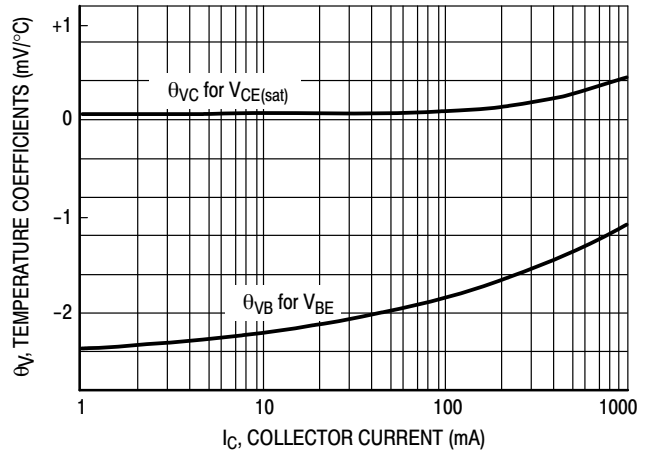

Figure 22. Temperature Coefficients

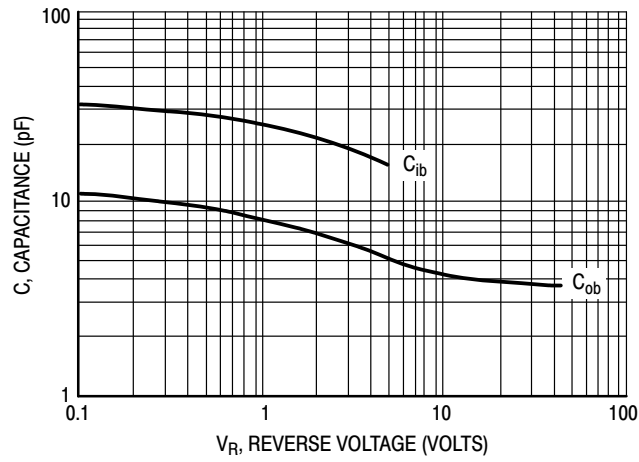
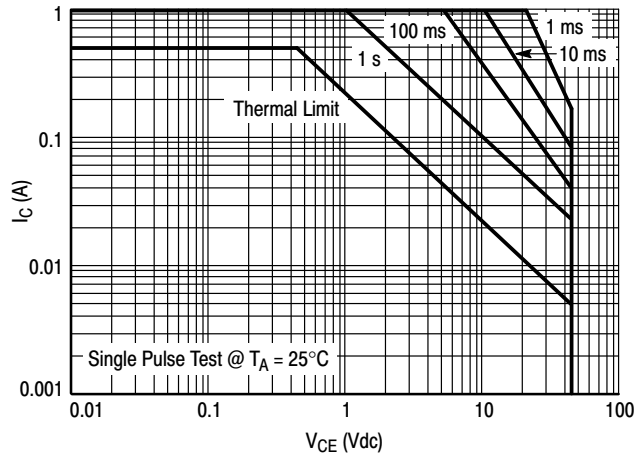

Figure 23. Capacitances

BC817-16L, SBC817-16L, BC817-25L, SBC817-25L, BC817-40L, SBC817-40L

TYPICAL CHARACTERISTICS - BC817-16L, SBC817-16L, BC817-25L, SBC817-25L, BC817-40L, SBC817-40L



PACKAGE DIMENSIONS

SOT-23 (TO-236)
CASE 318-08
ISSUE AS

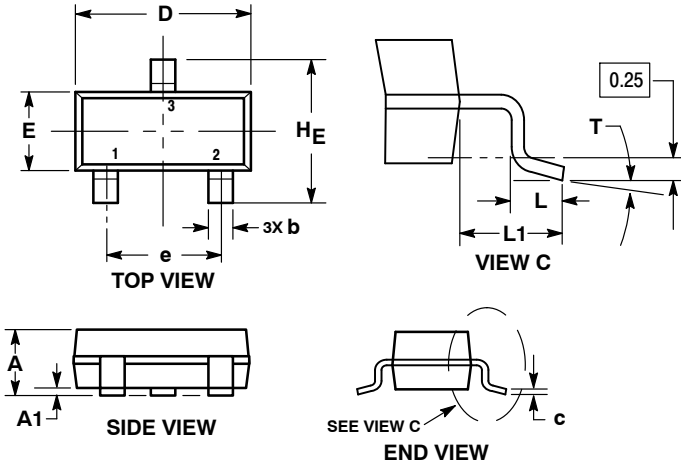

- NOTES:
1. DIMENSIONING AND TOLERANCING PER ASME Y14.5M, 1994.
 2. CONTROLLING DIMENSION: MILLIMETERS.
 3. MAXIMUM LEAD THICKNESS INCLUDES LEAD FINISH. MINIMUM LEAD THICKNESS IS THE MINIMUM THICKNESS OF THE BASE MATERIAL.
 4. DIMENSIONS D AND E DO NOT INCLUDE MOLD FLASH, PROTRUSIONS, OR GATE BURRS.

DIM	MILLIMETERS			INCHES		
	MIN	NOM	MAX	MIN	NOM	MAX
A	0.89	1.00	1.11	0.035	0.039	0.044
A1	0.01	0.06	0.10	0.000	0.002	0.004
b	0.37	0.44	0.50	0.015	0.017	0.020
c	0.08	0.14	0.20	0.003	0.006	0.008
D	2.80	2.90	3.04	0.110	0.114	0.120
E	1.20	1.30	1.40	0.047	0.051	0.055
e	1.78	1.90	2.04	0.070	0.075	0.080
L	0.30	0.43	0.55	0.012	0.017	0.022
L1	0.35	0.54	0.69	0.014	0.021	0.027
HE	2.10	2.40	2.64	0.083	0.094	0.104
T	0°	---	10°	0°	---	10°

- STYLE 6:
PIN 1. BASE
2. EMITTER
3. COLLECTOR

RECOMMENDED
SOLDERING FOOTPRINT*

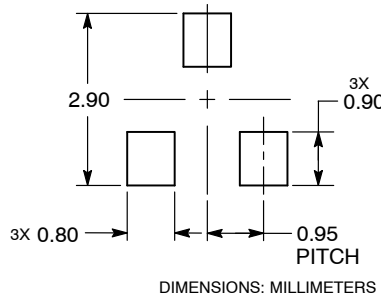

*For additional information on our Pb-Free strategy and soldering details, please download the ON Semiconductor Soldering and Mounting Techniques Reference Manual, SOLDERRM/D.

ON Semiconductor and are trademarks of Semiconductor Components Industries, LLC dba ON Semiconductor or its subsidiaries in the United States and/or other countries. ON Semiconductor owns the rights to a number of patents, trademarks, copyrights, trade secrets, and other intellectual property. A listing of ON Semiconductor's product/patent coverage may be accessed at www.onsemi.com/site/pdf/Patent-Marking.pdf. ON Semiconductor reserves the right to make changes without further notice to any products herein. ON Semiconductor makes no warranty, representation or guarantee regarding the suitability of its products for any particular purpose, nor does ON Semiconductor assume any liability arising out of the application or use of any product or circuit, and specifically disclaims any and all liability, including without limitation special, consequential or incidental damages. Buyer is responsible for its products and applications using ON Semiconductor products, including compliance with all laws, regulations and safety requirements or standards, regardless of any support or applications information provided by ON Semiconductor. "Typical" parameters which may be provided in ON Semiconductor data sheets and/or specifications can and do vary in different applications and actual performance may vary over time. All operating parameters, including "Typicals" must be validated for each customer application by customer's technical experts. ON Semiconductor does not convey any license under its patent rights nor the rights of others. ON Semiconductor products are not designed, intended, or authorized for use as a critical component in life support systems or any FDA Class 3 medical devices or medical devices with a same or similar classification in a foreign jurisdiction or any devices intended for implantation in the human body. Should Buyer purchase or use ON Semiconductor products for any such unintended or unauthorized application, Buyer shall indemnify and hold ON Semiconductor and its officers, employees, subsidiaries, affiliates, and distributors harmless against all claims, costs, damages, and expenses, and reasonable attorney fees arising out of, directly or indirectly, any claim of personal injury or death associated with such unintended or unauthorized use, even if such claim alleges that ON Semiconductor was negligent regarding the design or manufacture of the part. ON Semiconductor is an Equal Opportunity/Affirmative Action Employer. This literature is subject to all applicable copyright laws and is not for resale in any manner.

PUBLICATION ORDERING INFORMATION

LITERATURE FULFILLMENT:
Literature Distribution Center for ON Semiconductor
19521 E. 32nd Pkwy, Aurora, Colorado 80011 USA
Phone: 303-675-2175 or 800-344-3860 Toll Free USA/Canada
Fax: 303-675-2176 or 800-344-3867 Toll Free USA/Canada
Email: orderlit@onsemi.com

N. American Technical Support: 800-282-9855 Toll Free
USA/Canada
Europe, Middle East and Africa Technical Support:
Phone: 421 33 790 2910

ON Semiconductor Website: www.onsemi.com
Order Literature: <http://www.onsemi.com/orderlit>

For additional information, please contact your local Sales Representative